

# CATALOGUS 1.1

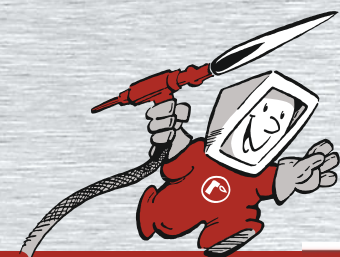

08/2013

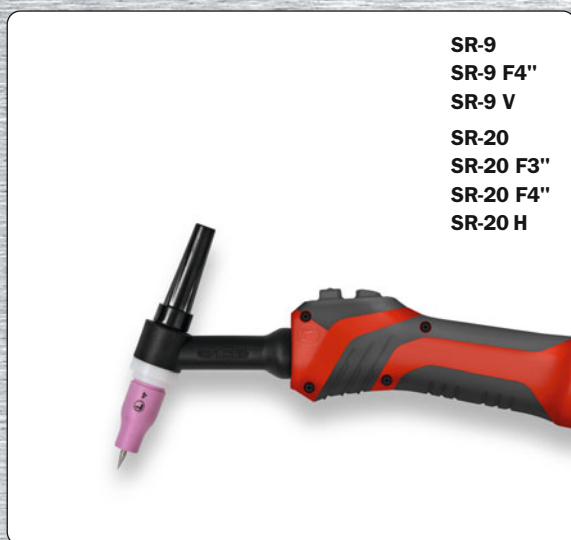

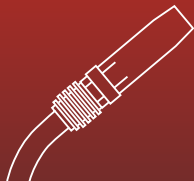
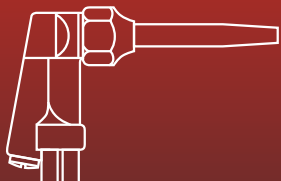

## Rohrman Schweißtechnik

# Lastoortsen en meer ... Partner van de vakhandel

Rohrman Schweißtechnik – een familie onderneming met meer dan 40 jaar ervaring in de lastechniek.

Wij bieden verschillende lastechnische producten aan, zoals:

- TIG lastoortsen met verschillende Konstruktie
- TIG slijtdelen en accessoires
- TIG Verlengingsslangpaketten
- MIG/MAG lastoortsen met verschillende Konstuktie
- MIG/MAG slijtdelen en accessoires
- MIG/MAG tussen- en verlengingsslangpaketten
- Elektroden- en massenkabels
- Automatische Lashelmen
- Autogen snijbranders, autogen slangen en accessoires
- Gutstangen voor koolelektroden en accessoires

Naast onze standaard producten hebben wij ons of het **TIG**-lassen gespecialiseerd. Hiervoor bieden wij een groot produkt spektrum, zodat wij voor de verschillende lasproblemen een oplossing voorstellen kunnen.

Vraag de vakhandel of laat u door ons adviseren (in de nederlandse taal).

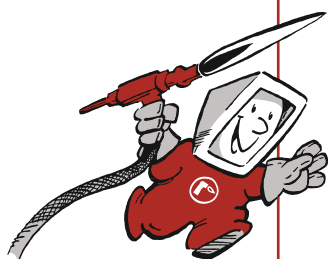

### Rohrman Schweißtechnik

Tel.: +49(0)21 62/10 60 65-0

Fax: +49(0)21 62/10 60 65-55

[www.rohrman.de](http://www.rohrman.de) · [info@rohrman.de](mailto:info@rohrman.de)

## TIG toorts serie SR

De TIG-lastoortsen van de serie SR leveren wij in de luchtgekoelde uitvoering tot een capaciteit van 200 A en de watergekoelde tot 400 A. De SR-serie heeft zijn naam afgeleid van "silikoon rubber" dat voor de isolering van het toortselichaam dient.

De TIG-lastoortsen worden voor het lassen van zeer verschillende metalen benut zoals staal, aluminium, magnesium, koper, nickel en titaan en anderen.

De lastoortsen zijn met onze nieuwe handgreep **RTC – Rohrman TIG Comfort** uitgevoerd. Deze handgreep is ergonomisch gevormt en heeft kunststof pads voor een vaste greep. Passend voor de verschillende afmetingen van de TIG toortsen hebben wij twee afmetingen, een kleine korte voor de modellen SR-9/17/20/24 en een grotere voor de SR-18/18SC/26. De bedienelementen zijn optimaal geplaatst, zodat de lasser zijn controle niet verliest bij het schakelen en regelen. De verschillende bedien-elementen, zoals enkel/dubbel-druk, enkeldruk up/down, dubbeldruk up/down en enkeldruk potentiometer zijn respectievelijk afhankelijk van de lasmaschine.

Rohrman Schweißtechnik levert lastoortsen voor zeer verschillende toepassingen aangepast aan elke lasmaschine. Ons grote assortiment maakt het ons mogelijk voor bijzondere toepassingen speciale oplossingen aan te bieden.

Laat u door Uw vakhandelaar of door het Rohrman team adviseren.



SR-20

SR-24

SR-18

SR-18 SC

**Enkeldruk-/  
Dubbeldrukschakelaar**



**Enkeldrukschakelaar  
up/down**



**Enkeldrukschakelaar  
met potentiometer**

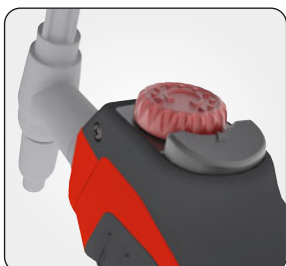

**Dubbeldrukschakelaar  
up/down**



**Flexibele toortsen**

# Prestatie tabel TIG toorts serie SR

## luchtgekoeld

Toorts type	Capaciteit		Inschakelduur ID	Ø Electrode
	DC	AC		
<b>SR-9</b>	120 A	85 A	35 %	0,5–1,6
<b>SR-17</b>	140 A	100 A	35 %	0,5–2,4
<b>SR-24 G</b>	110 A	75 A	35 %	0,5–1,6
<b>SR-26</b>	200 A	140 A	35 %	0,5–3,2

Technische gegevens naar EN 60 974-7 ☺



## watergekoeld

Toorts type	Capaciteit		Inschakelduur ID	Ø Electrode
	DC	AC		
<b>SR-18</b>	340 A	240 A	100 %	0,5–4,0
<b>SR-18 SC</b>	400 A	280 A	100 %	1,0–4,8
<b>SR-20</b>	240 A	170 A	100 %	0,5–3,2
<b>SR-20 H</b>	270 A	190 A	100 %	0,5–3,2
<b>SR-24 W</b>	180 A	125 A	100 %	0,5–2,4

Technische gegevens naar EN 60 974-7 ☺



### Slangpakketten met basis aansluiting

#### voor **SR-9/SR-9 F/SR-9 F4"/SR-17/SR-17 F/SR-24 G/SR-26/SR-26 F:**

Slangpakket met basis aansluiting EB

Stroomgaskabel . . . . . G1/4", wartel rechts met wellen slang als knikbescherming

Stuurkabel . . . . . open, 30 cm langer als stroomgaskabel

#### voor **SR-9 V/SR-17 V/SR-26 V:**

Slangpakket met basis aansluiting EO

Stroomgaskabel . . . . . G1/4", wartel rechts

#### voor **SR-18/SR-18 F/SR-18 SC/SR-20 F/SR-20 F3"/SR-20 F4"/SR-20 H/SR-24 W:**

Slangpakket met basis aansluiting EA

Stroomwaterkabel . . . . . M12x1 wartel rechts met wellen slang als knikbescherming

Water voorloop . . . . . open, 30 cm langer als stroomwaterkabel

Gas slang . . . . . open, 30 cm langer als stroomwaterkabel

Stuurkabel . . . . . open, 30 cm langer als stroomwaterkabel

Technische specificatie zonder garantie

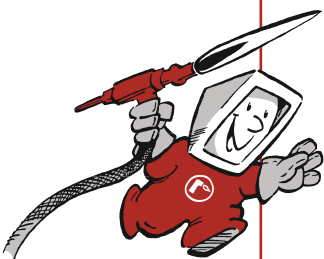

### Copyright

Voor alle teksten, afbeeldingen, tekeningen en andere informatie, die in deze catalogus gepubliceerd zijn – voor zover niet anders vermerkt – geldt het copyright van Rohrman Schweißtechnik GmbH. Het kopiëren, ook gedeeltelijk, is alleen met de schriftelijke toestemming van Rohrman Schweißtechnik GmbH toegelaten.



**ROHRMAN**  
SCHWEISSTECHNIK



## Verslijtonderdelen SR-9/20



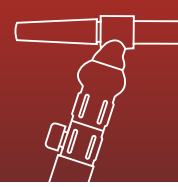
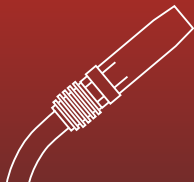
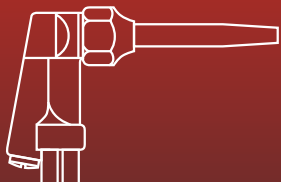

## Verslijtonderdelen SR-9/SR-20

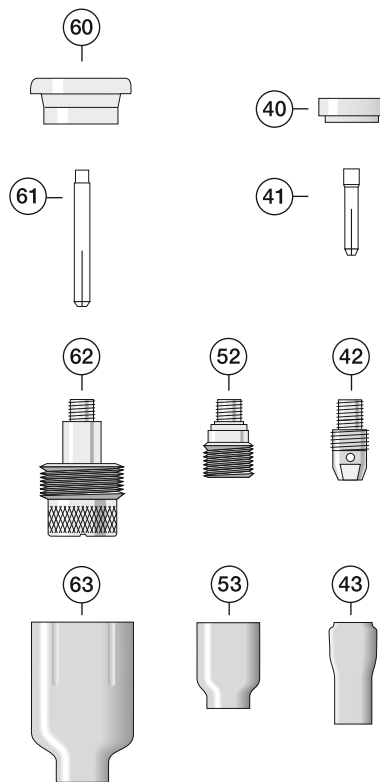
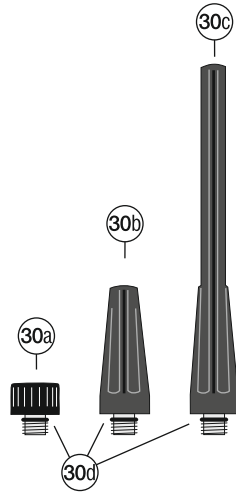

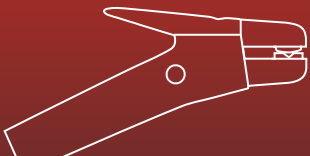
**Verslijtonderdelen SR-9/20**

<b>Positie</b>	<b>Artikelbeschrijving</b>	<b>Bestelnummer</b>
30a	Toortskap Kort L=19 mm	85741330
30b	Toortskap Midden L=50 mm	85741350
30c	Toortskap Lang L=145 mm	85741240
30d	O-Ring Rood	8550904520R
40	Isolator	85504820
41	Spantang Ø 0,5 mm L=25 mm	85113200
	Spantang Ø 1,0 mm L=25 mm	85113210
	Spantang Ø 1,6 mm L=25 mm	85113220
	Spantang Ø 2,4 mm L=25 mm	85113230
	Spantang Ø 3,2 mm L=25 mm	85113240
42	Spantanghouder Ø 0,5 mm L=21 mm	85123250
	Spantanghouder Ø 1,0 mm L=21 mm	85123260
	Spantanghouder Ø 1,6 mm L=21 mm	85123270
	Spantanghouder Ø 2,4 mm L=21 mm	85123280
	Spantanghouder Ø 3,2 mm L=21 mm	85123290
43	Keramisch Gasmondstuk Gr. # 4 Ø 6,4 mm L=30 mm	85213080
	Keramisch Gasmondstuk Gr. # 5 Ø 8,0 mm L=30 mm	85213090
	Keramisch Gasmondstuk Gr. # 6 Ø 9,6 mm L=30 mm	85213100
	Keramisch Gasmondstuk Gr. # 7 Ø 11,2 mm L=30 mm	85213110
	Keramisch Gasmondstuk Gr. # 8 Ø 12,8 mm L=30 mm	85213120
	Keramisch Gasmondstuk Gr. # 10 Ø 16,0 mm L=30 mm	85213130
52	Gaslens Standaard Ø 0,5 mm L=22 mm	85134541
	Gaslens Standaard Ø 1,0 mm L=22 mm	85134542
	Gaslens Standaard Ø 1,6 mm L=22 mm	85134543
	Gaslens Standaard Ø 2,4 mm L=22 mm	85134544
	Gaslens Standaard Ø 3,2 mm L=22 mm	85134545
53	Keramisch Gasmondstuk Gr. # 4 Ø 6,4 mm L=25 mm	85253580
	Keramisch Gasmondstuk Gr. # 5 Ø 8,0 mm L=25 mm	85253590
	Keramisch Gasmondstuk Gr. # 6 Ø 9,6 mm L=25 mm	85253600
	Keramisch Gasmondstuk Gr. # 7 Ø 11,2 mm L=25 mm	85253610
	Keramisch Gasmondstuk Gr. # 8 Ø 12,8 mm L=25 mm	85253612
60	Isolator Dichting Jumbo	85504632
61	Spantang Jumbo Ø 0,5 mm L=40 mm	85113204
	Spantang Jumbo Ø 1,0 mm L=40 mm	85113214
	Spantang Jumbo Ø 1,6 mm L=40 mm	85113224
	Spantang Jumbo Ø 2,4 mm L=40 mm	85113234
	Spantang Jumbo Ø 3,2 mm L=40 mm	85113244
62	Gaslens Jumbo Ø 0,5 – 1,0 mm L=41 mm	85136504
	Gaslens Jumbo Ø 1,6 mm L=41 mm	85136516
	Gaslens Jumbo Ø 2,4 mm L=41 mm	85136564
	Gaslens Jumbo Ø 3,2 mm L=41 mm	85136795
63	Keramisch Gasmondstuk Jumbo Gr. # 6 Ø 9,6 mm L=48 mm	85257750
	Keramisch Gasmondstuk Jumbo Gr. # 8 Ø 12,8 mm L=48 mm	85257740
	Keramisch Gasmondstuk Jumbo Gr. # 10 Ø 16,0 mm L=48 mm	85253880
	Keramisch Gasmondstuk Jumbo Gr. # 12 Ø 19,6 mm L=48 mm	85253870

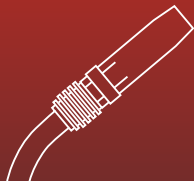
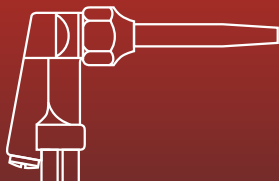

**De slijtonderdelen set SR-9/20 bestaat uit:**

**1x Toortskap Lang, 1x Spantang, 1x Spantanghouder, 1x Keramisch Gasmondstuk**  
**(verpakt in een doorzichtige verpakking)**

Positie	Artikelbeschrijving	Bestelnummer
	Slijtonderdelen Set Ø 0,5 mm	855220200-05
	Slijtonderdelen Set Ø 1,0 mm	855220200-10
	Slijtonderdelen Set Ø 1,6 mm	855220200-16
	Slijtonderdelen Set Ø 2,4 mm	855220200-24
	Slijtonderdelen Set Ø 3,2 mm	855220200-32

**Doorzichtbare box slijtonderdelen voor SR-9/20 bestaat uit:**

**1x Isolator, 1x Toortskap Kort /Midden /Lang,**  
**2x Spantang, 2x Spantanghouder, 2x Keramisch Gasmondstuk,**  
**2x Gaslens, 2x Keramisch Gasmondstuk (Gaslens)**  
**(verpakt in een doorzichtbare box)**

Positie	Artikelbeschrijving	Bestelnummer
	Slijtonderdelen Box Ø 0,5 mm	855220200-B05
	Slijtonderdelen Box Ø 1,0 mm	855220200-B10
	Slijtonderdelen Box Ø 1,6 mm	855220200-B16
	Slijtonderdelen Box Ø 2,4 mm	855220200-B24
	Slijtonderdelen Box Ø 3,2 mm	855220200-B32



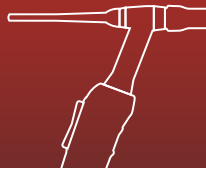

**Verslijtonderdelen SR-17/18/26**



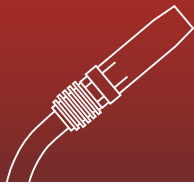
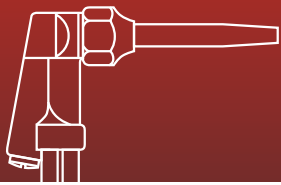

## Verslijtonderdelen SR-17/18/26

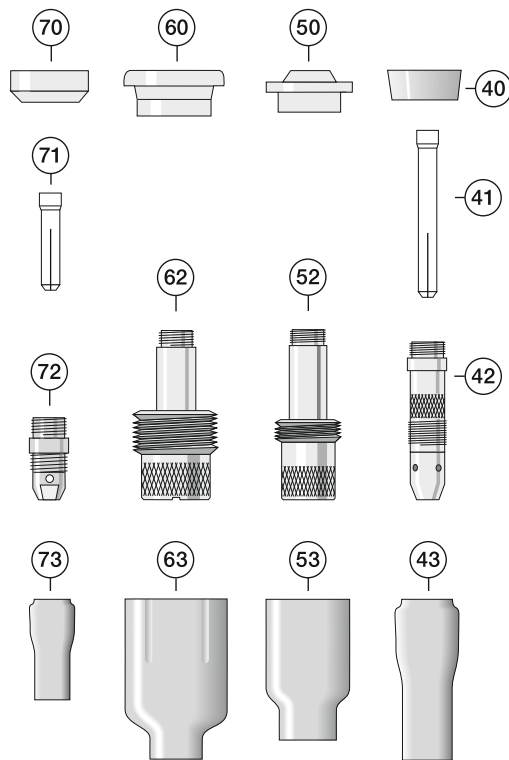
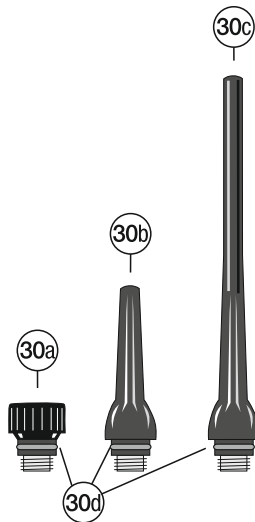

**Verslijtonderdelen SR-17/18/26**

Positie	Artikelbeschrijving	Bestelnummer
30a	Toortskap Kort L=25 mm	85757040
30b	Toortskap Midden L=60 mm	85757030
30c	Toortskap Lang L=120 mm	85757020
30d	O-Ring Rood Voor Toortskap	8550908017R
40	Isolator Standaard	85504181
41	Spantang Ø 0,5 mm L=50 mm	85110210
	Spantang Ø 1,0 mm L=50 mm	85110220
	Spantang Ø 1,6 mm L=50 mm	85110230
	Spantang Ø 2,4 mm L=50 mm	85110240
	Spantang Ø 3,2 mm L=50 mm	85110250
	Spantang Ø 4,0 mm L=50 mm	85114200
42	Spantanghouder Ø 0,5 mm L=47 mm	85120290
	Spantanghouder Ø 1,0 mm L=47 mm	85120300
	Spantanghouder Ø 1,6 mm L=47 mm	85120310
	Spantanghouder Ø 2,4 mm L=47 mm	85120320
	Spantanghouder Ø 3,2 mm L=47 mm	85120280
	Spantanghouder Ø 4,0 mm L=47 mm	85124880
43	Keramisch Gasmondstuk Gr. # 4 Ø 6,4 mm L=47 mm	85210500
	Keramisch Gasmondstuk Gr. # 5 Ø 8,0 mm L=47 mm	85210490
	Keramisch Gasmondstuk Gr. # 6 Ø 9,6 mm L=47 mm	85210480
	Keramisch Gasmondstuk Gr. # 7 Ø 11,2 mm L=47 mm	85210470
	Keramisch Gasmondstuk Gr. # 8 Ø 12,8 mm L=47 mm	85210460
	Keramisch Gasmondstuk Gr. # 10 Ø 16,0 mm L=47 mm	85210450
	Keramisch Gasmondstuk Gr. # 12 Ø 19,2 mm L=47 mm	85210440
50	Dichting Voor Standaard Gaslens	85504010
52	Gaslens Standaard Ø 0,5 mm L=50 mm	85134529
	Gaslens Standaard Ø 1,0 mm L=50 mm	85134524
	Gaslens Standaard Ø 1,6 mm L=50 mm	85134525
	Gaslens Standaard Ø 2,4 mm L=50 mm	85134526
	Gaslens Standaard Ø 3,2 mm L=50 mm	85134527
	Gaslens Standaard Ø 4,0 mm L=50 mm	85134528
53	Keramisch Gasmondstuk Gr. # 4 Ø 6,4 mm L=42 mm	85254180
	Keramisch Gasmondstuk Gr. # 5 Ø 8,0 mm L=42 mm	85254170
	Keramisch Gasmondstuk Gr. # 6 Ø 9,6 mm L=42 mm	85254160
	Keramisch Gasmondstuk Gr. # 7 Ø 11,2 mm L=42 mm	85254150
	Keramisch Gasmondstuk Gr. # 8 Ø 12,8 mm L=42 mm	85254140
	Keramisch Gasmondstuk Gr. # 10 Ø 16,0 mm L=42 mm	85254120
	Keramisch Gasmondstuk Gr. # 12 Ø 19,2 mm L=42 mm	85254100
60	Isolator Dichting Jumbo	85504630
62	Gaslens Jumbo Ø 0,5-1,0 mm L=50 mm	85134502
	Gaslens Jumbo Ø 1,6 mm L=50 mm	85134516
	Gaslens Jumbo Ø 2,4 mm L=50 mm	85134564
	Gaslens Jumbo Ø 3,2 mm L=50 mm	85135795
	Gaslens Jumbo Ø 4,0 mm L=50 mm	85134563
63	Keramisch Gasmondstuk Jumbo Gr. # 6 Ø 9,6 mm L=48 mm	85257750
	Keramisch Gasmondstuk Jumbo Gr. # 8 Ø 12,8 mm L=48 mm	85257740
	Keramisch Gasmondstuk Jumbo Gr. # 10 Ø 16,0 mm L=48 mm	85253880
	Keramisch Gasmondstuk Jumbo Gr. # 12 Ø 19,2 mm L=48 mm	85253870

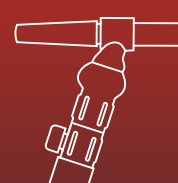
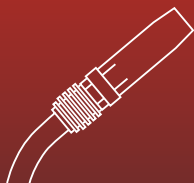
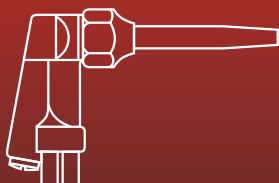

## Verslijtonderdelen SR-17/18/26

Positie	Artikelbeschrijving	Bestelnummer
70	Isolator Voor Ombouw	85504182
71	Spantang Voor Ombouw Ø 1,6 mm L=29,5 mm	85110231
	Spantang Voor Ombouw Ø 2,4 mm L=29,5 mm	85110241
	Spantang Voor Ombouw Ø 3,2 mm L=29,5 mm	85110251
72	Spantanghouder Voor Ombouw Ø 1,6–3,2 mm	85122000
73	Keramisch Gasmondstuk Gr. # 4 Ø 6,4 mm L=30 mm	85213080
	Keramisch Gasmondstuk Gr. # 5 Ø 8,0 mm L=30 mm	85213090
	Keramisch Gasmondstuk Gr. # 6 Ø 9,6 mm L=30 mm	85213100
	Keramisch Gasmondstuk Gr. # 7 Ø 11,2 mm L=30 mm	85213110
	Keramisch Gasmondstuk Gr. # 8 Ø 12,8 mm L=30 mm	85213120
	Keramisch Gasmondstuk Gr. # 10 Ø 16,0 mm L=30 mm	85213130
	Spantang Voor Ombouw Ø 1,6 mm L=33 mm	85110230GB
	Spantang Voor Ombouw Ø 2,4 mm L=33 mm	85110240GB
	Spantang Voor Ombouw Ø 3,2 mm L=33 mm	85110250GB
	Gaslens Voor Ombouw Ø 1,6 mm	85134551
	Gaslens Voor Ombouw Ø 2,4 mm	85134552
	Gaslens Voor Ombouw Ø 3,2 mm	85134553
	Keramisch Gasmondstuk Gr. # 4 Ø 6,4 mm L=25 mm	85253580
	Keramisch Gasmondstuk Gr. # 5 Ø 8,0 mm L=25 mm	85253590
	Keramisch Gasmondstuk Gr. # 6 Ø 9,6 mm L=25 mm	85253600
	Keramisch Gasmondstuk Gr. # 7 Ø 11,2 mm L=25 mm	84253610
	Keramisch Gasmondstuk Gr. # 8 Ø 12,8 mm L=25 mm	84253612

### De slijtonderdelen set SR-17/18/26 bestaat uit:

**1x Toortskap Lang, 1x Spantang, 1x Spantanghouder, 1x Keramisch Gasmondstuk (verpakt in een doorzichtige verpakking)**

Positie	Artikelbeschrijving	Bestelnummer
	Slijtonderdelen Set Ø 1,0 mm	855220170-10
	Slijtonderdelen Set Ø 1,6 mm	855220170-16
	Slijtonderdelen Set Ø 2,4 mm	855220170-24
	Slijtonderdelen Set Ø 3,2 mm	855220170-32
	Slijtonderdelen Set Ø 4,0 mm	855220170-40

### Doorzichtbare box slijtonderdelen voor SR-17/18/26 bestaat uit:

**1x Isolator, 1x Toortskap Kort /Midden /Lang,  
2x Spantang, 2x Spantanghouder, 2x Keramisch Gasmondstuk,  
1x Dichting Voor Gaslens, 2x Gaslens, 2x Keramisch Gasmondstuk (Gaslens)  
(verpakt in een doorzichtbare box)**

Positie	Artikelbeschrijving	Bestelnummer
	Slijtonderdelen Box Ø 1,0 mm	855220170-B10
	Slijtonderdelen Box Ø 1,6 mm	855220170-B16
	Slijtonderdelen Box Ø 2,4 mm	855220170-B24
	Slijtonderdelen Box Ø 3,2 mm	855220170-B32
	Slijtonderdelen Box Ø 4,0 mm	855220170-B40

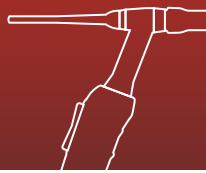

**Verslijtonderdelen SR-18 SC**



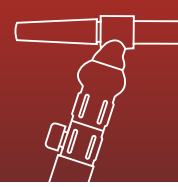
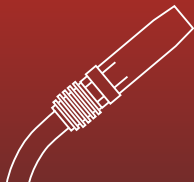
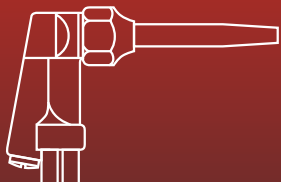

## Verslijtonderdelen SR-18 SC

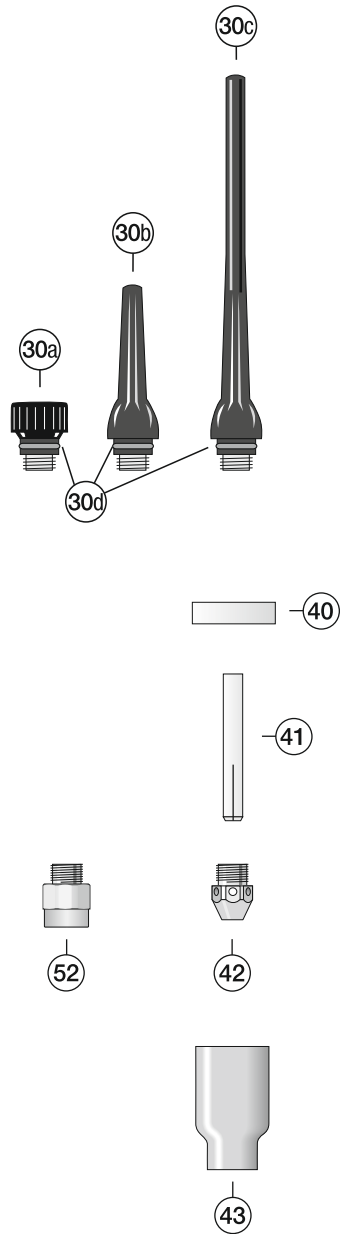

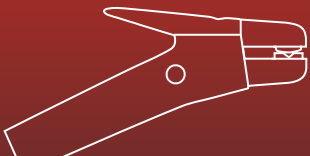
**Verslijtonderdelen SR-18 SC**

<b>Positie</b>	<b>Artikelbeschrijving</b>	<b>Bestelnummer</b>
30a	Toortskap Kort L=25 mm	85757040
30b	Toortskap Midden L=60 mm	85757030
30c	Toortskap Lang L=120 mm	85757020
30d	O-Ring	8550908017R
40	Isolator	85504186
41	Spantang Ø 1,0 mm L=49 mm	85110220HD
	Spantang Ø 1,6 mm L=49 mm	85110230HD
	Spantang Ø 2,4 mm L=49 mm	85110240HD
	Spantang Ø 3,2 mm L=49 mm	85110250HD
	Spantang Ø 4,0 mm L=49 mm	85114200HD
	Spantang Ø 4,8 mm L=49 mm	85118360HD
42	Spantanghouder Ø 1,0-3,2 mm L=29,5 mm	85120530
	Spantanghouder Ø 3,2-4,8 mm L=29,5 mm	85120360
52	Gaslens Standaard Ø 1,0 mm L=21 mm	85131804
	Gaslens Standaard Ø 1,6 mm L=21 mm	85131806
	Gaslens Standaard Ø 2,4 mm L=21 mm	85131832
	Gaslens Standaard Ø 3,2 mm L=21 mm	85131818
	Gaslens Standaard Ø 4,0 mm L=21 mm	85131853
	Gaslens Standaard Ø 4,8 mm L=21 mm	85131836
43	Keramisch Gasmondstuk Gr. # 4 Ø 6,4 mm L=42 mm	85254180
	Keramisch Gasmondstuk Gr. # 5 Ø 8,0 mm L=42 mm	85254170
	Keramisch Gasmondstuk Gr. # 6 Ø 9,6 mm L=42 mm	85254160
	Keramisch Gasmondstuk Gr. # 7 Ø 11, 2 mm L=42 mm	85254150
	Keramisch Gasmondstuk Gr. # 8 Ø 12,8 mm L=42 mm	85254140
	Keramisch Gasmondstuk Gr. # 10 Ø 16,0 mm L=42 mm	85254120
	Keramisch Gasmondstuk Gr. # 12 Ø 19,2 mm L=42 mm	85254100

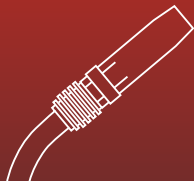
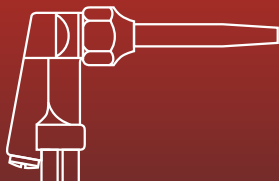

**De slijtonderdelen set SR-18 SC bestaat uit:**

**1x Toortskap Lang, 1x Spantang, 1x Spantanghouder, 1x Keramisch Gasmondstuk**  
**(verpakt in een doorzichtige verpakking)**

Positie	Artikelbeschrijving	Bestelnummer
	Slijtonderdelen Set Ø 1,0 mm	85522018C-10
	Slijtonderdelen Set Ø 1,6 mm	85522018C-16
	Slijtonderdelen Set Ø 2,4 mm	85522018C-24
	Slijtonderdelen Set Ø 3,2 mm	85522018C-32
	Slijtonderdelen Set Ø 4,0 mm	85522018C-40
	Slijtonderdelen Set Ø 4,8 mm	85522018C-48

**Doorzichtbare box slijtonderdelen voor SR-18 SC bestaat uit:**

**1x Isolator, 1x Toortskap Kort /Midden /Lang,**  
**2x Spantang, 2x Spantanghouder, 2x Keramisch Gasmondstuk,**  
**2x Gaslens, 2x Keramisch Gasmondstuk (Gaslens)**  
**(verpakt in een doorzichtbare box)**

Positie	Artikelbeschrijving	Bestelnummer
	Slijtonderdelen Box Ø 1,0 mm	85522018C-B10
	Slijtonderdelen Box Ø 1,6 mm	85522018C-B16
	Slijtonderdelen Box Ø 2,4 mm	85522018C-B24
	Slijtonderdelen Box Ø 3,2 mm	85522018C-B32
	Slijtonderdelen Box Ø 4,0 mm	85522018C-B40
	Slijtonderdelen Box Ø 4,8 mm	85522018C-B48



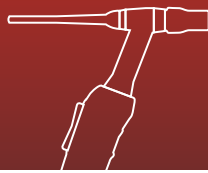

## Verslijtonderdelen SR-24

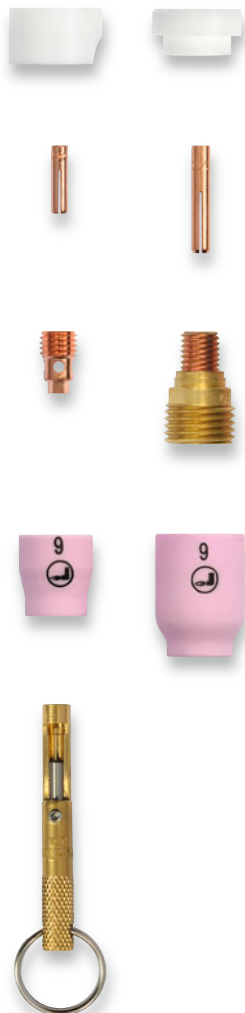

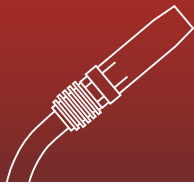
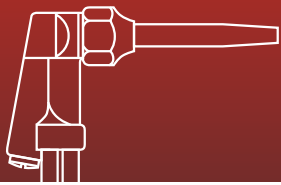

## Verslijtonderdelen SR-24

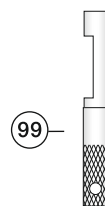
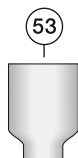

**Verslijtonderdelen SR-24**

<b>Positie</b>	<b>Artikelbeschrijving</b>	<b>Bestelnummer</b>
40	Isolator	85504222
41	Spantang Ø 0,5 mm L=14 mm	85113150
	Spantang Ø 1,0 mm L=14 mm	85113160
	Spantang Ø 1,6 mm L=14 mm	85113140
	Spantang Ø 2,4 mm L=14 mm	85113320
42	Spantanghouder Ø 0,5 mm	85123170
	Spantanghouder Ø 1,0 mm	85123180
	Spantanghouder Ø 1,6 mm	85123190
	Spantanghouder Ø 2,4 mm	85123320
43a	Keramisch Gasmondstuk Gr. # 4 Ø 6,4 mm L=16,5 mm	85253240
	Keramisch Gasmondstuk Gr. # 5 Ø 8,0 mm L=16,5 mm	85253250
	Keramisch Gasmondstuk Gr. # 6 Ø 9,6 mm L=16,5 mm	85253270
43b	Keramisch Gasmondstuk Gr. # 4 Ø 6,4 mm L=29 mm	85253280
	Keramisch Gasmondstuk Gr. # 6 Ø 9,6 mm L=29 mm	85253260
50	Isolator Voor Gaslens	85504660
51	Spantang Ø 0,5 mm L=23 mm	85113620
	Spantang Ø 1,0 mm L=23 mm	85113630
	Spantang Ø 1,6 mm L=23 mm	85113640
	Spantang Ø 2,4 mm L=23 mm	85113323
52	Gaslens Ø 0,5 mm	85134541
	Gaslens Ø 1,0 mm	85134542
	Gaslens Ø 1,6 mm	85134543
	Gaslens Ø 2,4 mm	85134544
53	Keramisch Gasmondstuk Gr. # 4 Ø 6,4 mm L=25 mm	85253580
	Keramisch Gasmondstuk Gr. # 5 Ø 8,0 mm L=25 mm	85253590
	Keramisch Gasmondstuk Gr. # 6 Ø 9,6 mm L=25 mm	85253600
	Keramisch Gasmondstuk Gr. # 7 Ø 11,2 mm L=25 mm	85253610
	Keramisch Gasmondstuk Gr. # 8 Ø 12,8 mm L=25 mm	85253612
99	Spansleutel	85521002

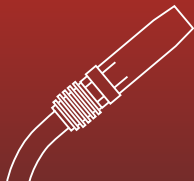
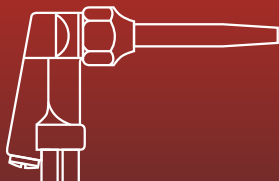

#### De slijtonderdelen set SR-24 bestaat uit:

**1x Spantang, 1x Spantanghouder, 1x Keramisch Gasmondstuk**

**(verpakt in een doorzichtige verpakking)**

Positie	Artikelbeschrijving	Bestelnummer
	Slijtonderdelen Set Ø 0,5 mm	85522024G-05
	Slijtonderdelen Set Ø 1,0 mm	85522024G-10
	Slijtonderdelen Set Ø 1,6 mm	85522024G-16
	Slijtonderdelen Set Ø 2,4 mm	85522024G-24

#### Doorzichtbare box slijtonderdelen voor SR-24 bestaat uit:

**1x Spansleutel, 1x Isolator, 2x Spantang,**

**2x Spantanghouder, 2x Keramisch Gasmondstuk, 1x Isolator (Gaslens),**

**2x Spantang (Gaslens), 2x Gaslens, 2x Keramisch Gasmondstuk (Gaslens)**

**(verpakt in een doorzichtbare box)**

Positie	Artikelbeschrijving	Bestelnummer
	Slijtonderdelen Box Ø 0,5 mm	85522024G-B05
	Slijtonderdelen Box Ø 1,0 mm	85522024G-B10
	Slijtonderdelen Box Ø 1,6 mm	85522024G-B16
	Slijtonderdelen Box Ø 2,4 mm	85522024G-B24

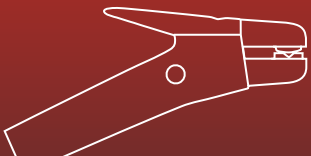

**ROHRMAN**  
SCHWEISSTECHNIK



**SR-9**



**SR-9 F4"**



**SR-9 V**



**TIG handlastoorts SR-9, SR-9 F4", SR-9 V**

Capaciteit bij 35% inschakelduur (10-min.-cyclus)	Koeling	Dia elektrode	Norm	Aansluiting
Gelijkstroom (DC) 120 A Wisselstroom (AC) 85 A	Luchtkoeling	0,5–1,6 mm	EN 60974-7 CE	Passend voor iedere lasmaschine

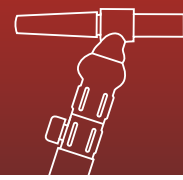
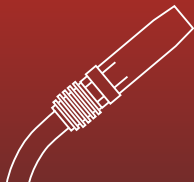
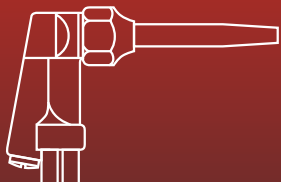

# SR-9/SR-9 F

120 A - DC - 35% ID  
85 A - AC - 35% ID

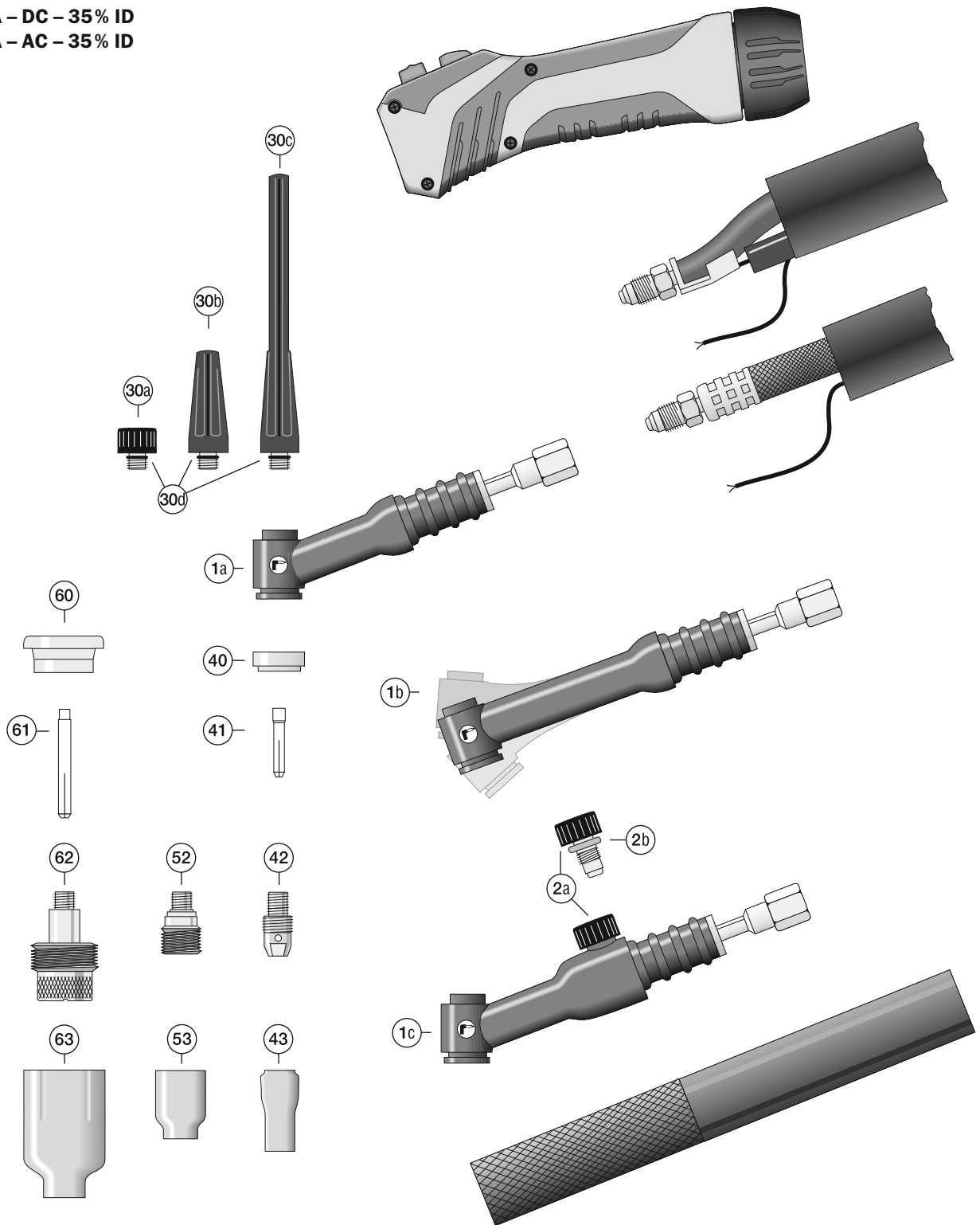

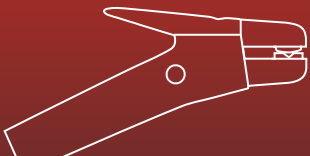
**TIG lastoorts SR-9 met Highflex (HF) slangpakket en basis aansluiting**

Positie	Artikelbeschrijving	Bestelnummer
	SR-9/4 m, Leder+Rubber, G-Cu-W, RTC-DD	84B1009004EB01D
	SR-9/8 m, Leder+Rubber, G-Cu-W, RTC-DD	84B1009008EB01D

**TIG lastoorts SR-9 F met Highflex (HF) slangpakket en basis aansluiting**

Positie	Artikelbeschrijving	Bestelnummer
	SR-9 F/4 m, Leder+Rubber, G-Cu-W, RTC-DD	84B1009204EB01D
	SR-9 F/8 m, Leder+Rubber, G-Cu-W, RTC-DD	84B1009208EB01D

**TIG lastoorts SR-9 F4" met Highflex (HF) slangpakket en basis aansluiting**

Positie	Artikelbeschrijving	Bestelnummer
	SR-9 F4"/4 m, Leder+Rubber, G-Cu-W, RTC-DD	84B1009404EB01D
	SR-9 F4"/8 m, Leder+Rubber, G-Cu-W, RTC-DD	84B1009408EB01D

**TIG lastoorts SR-9 V met stroom-/gaskabel en basis aansluiting**

Positie	Artikelbeschrijving	Bestelnummer
	SR-9 V/4 m, T-Cu, Handgreep Rond	8407009V04E030
	SR-9 V/8 m, T-Cu, Handgreep Rond	8407009V08E030

**TIG lastoorts SR-9 FV met stroom-/gaskabel en basis aansluiting**

Positie	Artikelbeschrijving	Bestelnummer
	SR-9 FV/4 m, T-Cu, Handgreep Rond	8407009Y04E030
	SR-9 FV/8 m, T-Cu, Handgreep Rond	8407009Y08E030

**Onderdelen toortslichaam**

Positie	Artikelbeschrijving	Bestelnummer
1a	Toortslichaam SR-9	85600090
	Toortslichaam SR-9 F Flexibel	85600092
1b	Toortslichaam SR-9 F4" (100 mm) Flexibel	85600094
1c	Toortslichaam SR-9 V Draaiventil Knop	8560009V
	Toortslichaam SR-9 FV Flexibel En Met Draaiventil Knop	8560009Y
2a	Draaiventil Knop Voor SR-9 V	85511002
2b	O-Ring Voor Draaiventil Knop	8550904520R

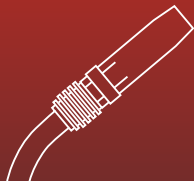
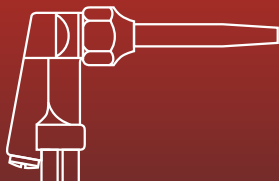

### TIG lastoorts SR-9 met Highflex-Weefsel bescherm slang (HFG) en basis aansluiting

Positie	Artikelbeschrijving	Bestelnummer
	SR-9/ 4 m, Leder+Weefsel Bescherm slang, G-Cu-W, RTC-DD	84F1009004EB01D
	SR-9/ 8 m, Leder+Weefsel Bescherm slang, G-Cu-W, RTC-DD	84F1009008EB01D
	SR-9/12 m, Leder+Weefsel Bescherm slang, G-Cu-W, RTC-DD	84F1009012EB01D
	SR-9/16 m, Leder+Weefsel Bescherm slang, G-Cu-W, RTC-DD	84F1009016EB01D

### TIG lastoorts SR-9 F met Highflex-Weefsel bescherm slang (HFG) en basis aansluiting

Positie	Artikelbeschrijving	Bestelnummer
	SR-9 F/ 4 m, Leder+Weefsel Bescherm slang, G-Cu-W, RTC-DD	84F1009204EB01D
	SR-9 F/ 8 m, Leder+Weefsel Bescherm slang, G-Cu-W, RTC-DD	84F1009208EB01D
	SR-9 F/12 m, Leder+Weefsel Bescherm slang, G-Cu-W, RTC-DD	84F1009212EB01D
	SR-9 F/16 m, Leder+Weefsel Bescherm slang, G-Cu-W, RTC-DD	84F1009216EB01D

### TIG lastoorts SR-9 F4" met Highflex-Weefsel bescherm slang (HFG) en basis aansluiting

Positie	Artikelbeschrijving	Bestelnummer
	SR-9 F4"/ 4 m, Leder+Weefsel Bescherm slang, G-Cu-W, RTC-DD	84F1009404EB01D
	SR-9 F4"/ 8 m, Leder+Weefsel Bescherm slang, G-Cu-W, RTC-DD	84F1009408EB01D
	SR-9 F4"/12 m, Leder+Weefsel Bescherm slang, G-Cu-W, RTC-DD	84F1009404EB01D
	SR-9 F4"/16 m, Leder+Weefsel Bescherm slang, G-Cu-W, RTC-DD	84F1009408EB01D



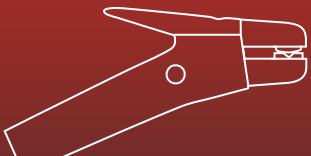

**ROHRMAN**  
SCHWEISSTECHNIK



**SR-17**



**SR-17 V**

**TIG handlastoorts SR-17, SR-17 V**

<b>Capaciteit bij 35% inschakelduur (10-min.-cyclus)</b>	<b>Koeling</b>	<b>Dia elektrode</b>	<b>Norm</b>	<b>Aansluiting</b>
Gelijkstroom (DC) 140 A Wisselstroom (AC) 100 A	Luchtkoeling	0,5–2,4 mm	EN 60974-7 CE	Passend voor iedere lasmaschine

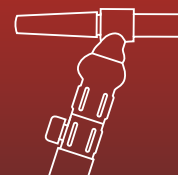
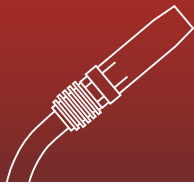
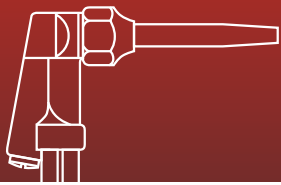

# SR-17/F/V

140 A - DC - 35% ID

100 A - AC - 35% ID

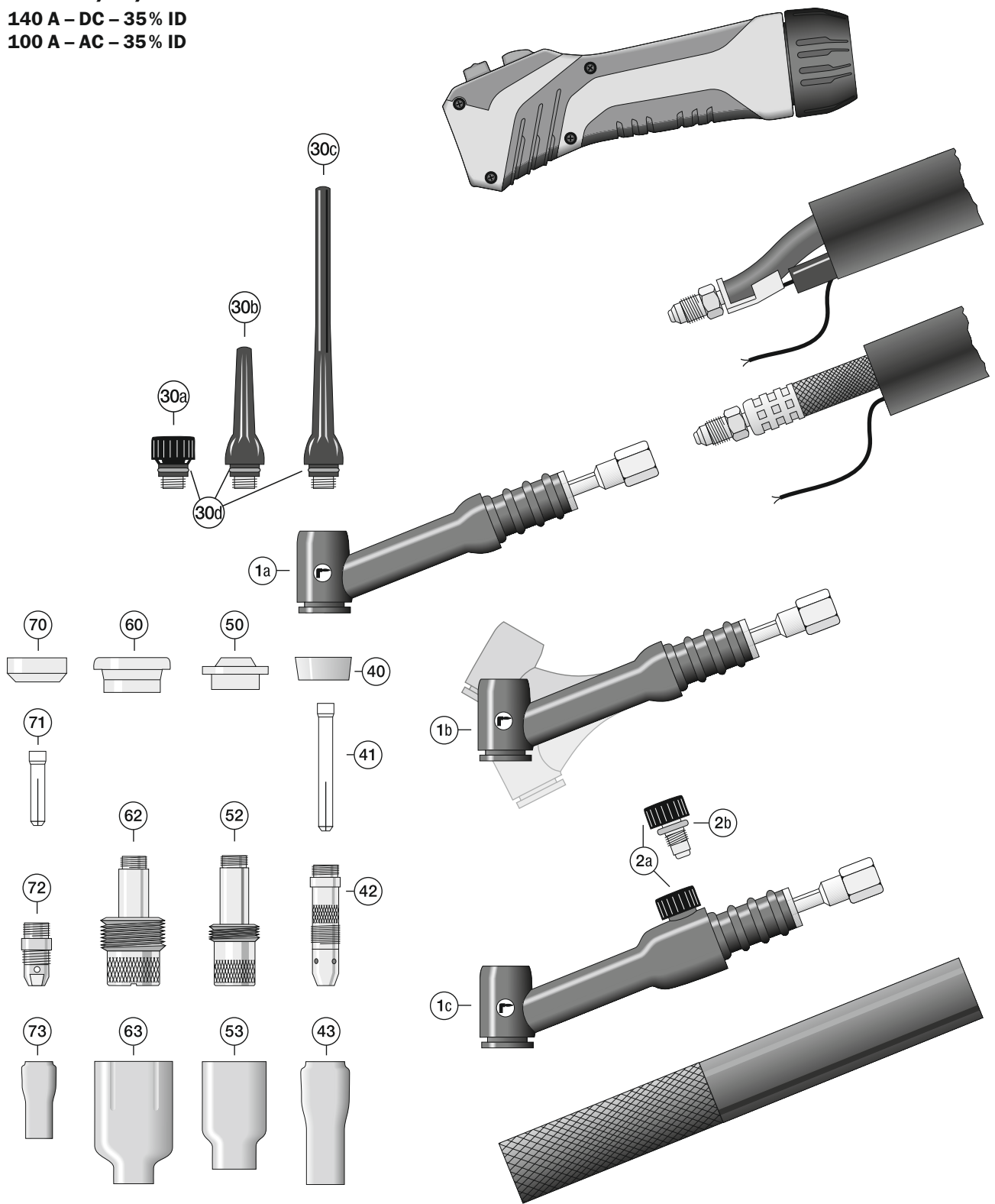



### TIG lastoorts SR-17 met Highflex (HF) slangpakket en basis aansluiting

Positie	Artikelbeschrijving	Bestelnummer
	SR-17/4 m, Leder+Rubber, G-Cu-W, RTC-DD	84B1017004EB01D
	SR-17/8 m, Leder+Rubber, G-Cu-W, RTC-DD	84B1017008EB01D

### TIG lastoorts SR-17 F met Highflex (HF) slangpakket en basis aansluiting

Positie	Artikelbeschrijving	Bestelnummer
	SR-17 F/4 m, Leder+Rubber, G-Cu-W, RTC-DD	84B1017204EB01D
	SR-17 F/8 m, Leder+Rubber, G-Cu-W, RTC-DD	84B1017208EB01D

### TIG lastoorts SR-17 V met stroom-/gaskabel en basis aansluiting

Positie	Artikelbeschrijving	Bestelnummer
	SR-17 V/4 m, T-Cu, Handgreep Rond	8407017V04E030
	SR-17 V/8 m, T-Cu, Handgreep Rond	8407017V08E030

### TIG lastoorts SR-17 FV met stroom-/gaskabel en basis aansluiting

Positie	Artikelbeschrijving	Bestelnummer
	SR-17 FV/4 m, T-Cu, Handgreep Rond	8407017Y04E030
	SR-17 FV/8 m, T-Cu, Handgreep Rond	8407017Y08E030

### Onderdelen toortslichaam

Positie	Artikelbeschrijving	Bestelnummer
1a	Toortslichaam SR-17	85600170
1b	Toortslichaam SR-17 F Flexibel	85600172
1c	Toortslichaam SR-17 V Draaiventil Knop	8560017V
	Toortslichaam SR-17 FV Flexibel en Met Draaiventil Knop	8560017Y
2a	Draaiventil Knop SR-17 V	85511002
2b	O-Ring	8550904520R

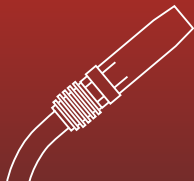
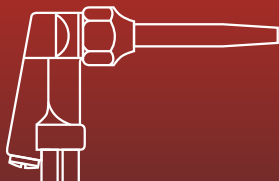

### TIG lastoorts SR-17 met Highflex-Weefsel bescherm slang (HFG) en basis aansluiting

Positie	Artikelbeschrijving	Bestelnummer
	SR-17/ 4 m, Leder+Weefsel Bescherm slang, G-Cu-W, RTC-DD	84F1017004EB01D
	SR-17/ 8 m, Leder+Weefsel Bescherm slang, G-Cu-W, RTC-DD	84F1017008EB01D
	SR-17/12 m, Leder+Weefsel Bescherm slang, G-Cu-W, RTC-DD	84F1017012EB01D
	SR-17/16 m, Leder+Weefsel Bescherm slang, G-Cu-W, RTC-DD	84F1017016EB01D

### TIG lastoorts SR-17 F met Highflex-Weefsel bescherm slang (HFG) en basis aansluiting

Positie	Artikelbeschrijving	Bestelnummer
	SR-17 F/ 4 m, Leder+Weefsel Bescherm slang, G-Cu-W, RTC-DD	84F1017204EB01D
	SR-17 F/ 8 m, Leder+Weefsel Bescherm slang, G-Cu-W, RTC-DD	84F1017208EB01D
	SR-17 F/12 m, Leder+Weefsel Bescherm slang, G-Cu-W, RTC-DD	84F1017212EB01D
	SR-17 F/16 m, Leder+Weefsel Bescherm slang, G-Cu-W, RTC-DD	84F1017216EB01D

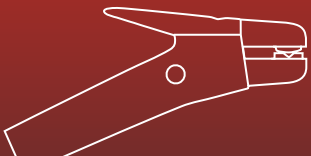

**ROHRMAN**  
SCHWEISSTECHNIK



**SR-18/F**

**TIG handlastoorts SR-18, SR-18 F**

<b>Capaciteit bij 100% inschakelduur (10-min.-cyclus)</b>	<b>Koeling</b>	<b>Dia electrode</b>	<b>Norm</b>	<b>Aansluiting</b>
Gelijkstroom (DC) 340 A Wisselstroom (AC) 240 A	Waterkoeling	0,5–4,0 mm	EN 60974-7 CE	Passend voor iedere lasmaschine

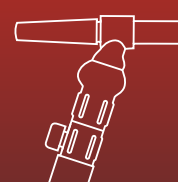
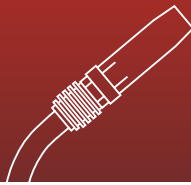
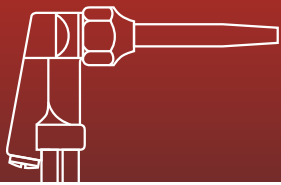

# SR-18/F

340 A - DC - 100% ID

240 A - AC - 100% ID

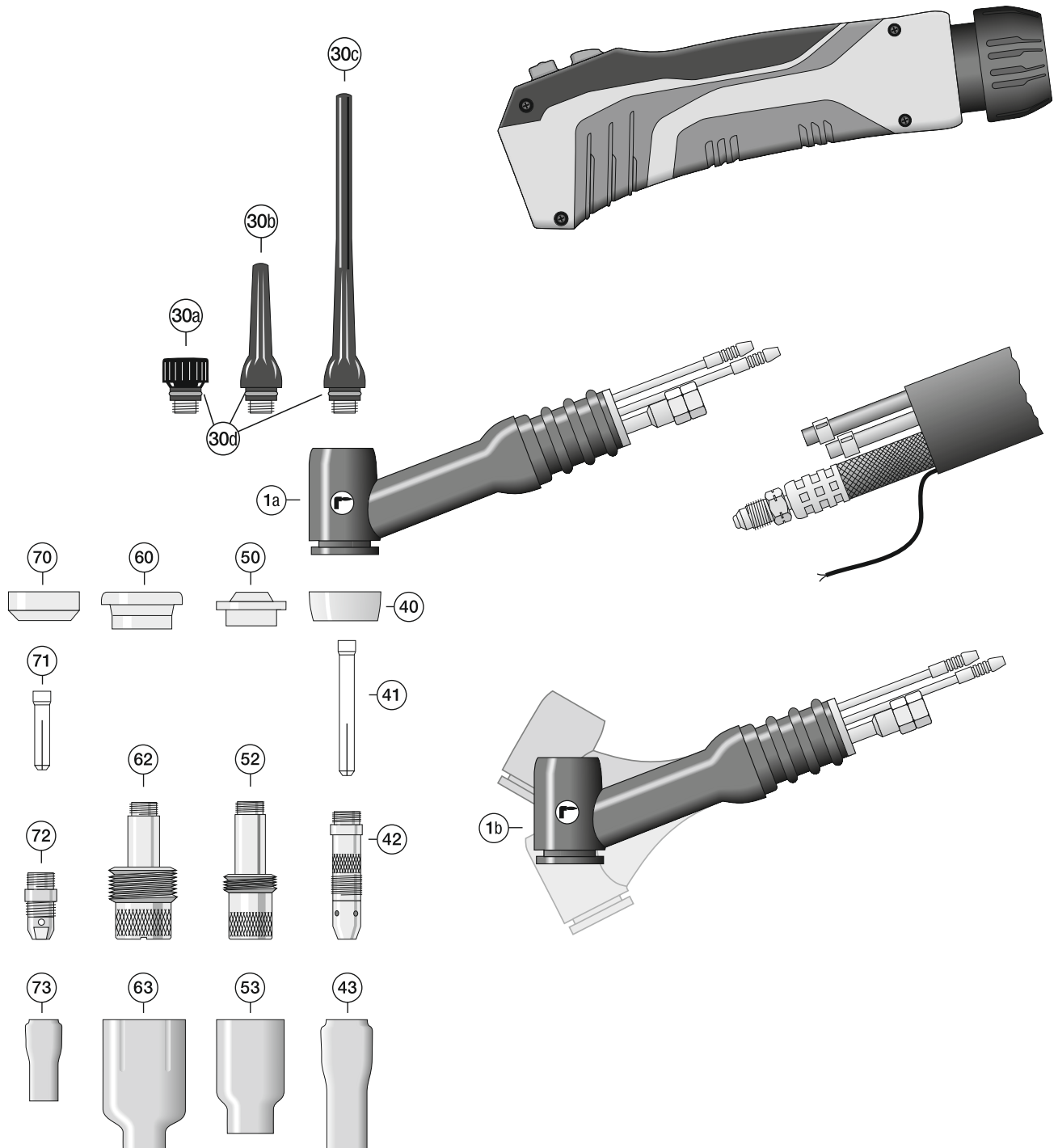

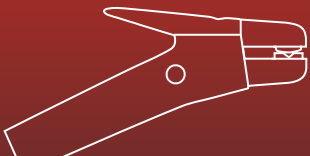

### TIG lastoorts SR-18 met Highflex (HF) slangpakket en basis aansluiting

Positie	Artikelbeschrijving	Bestelnummer
	SR-18/4 m, Leder+Rubber, G-Cu-W, RTC-DD	84B1018004EA01D
	SR-18/8 m, Leder+Rubber, G-Cu-W, RTC-DD	84B1018008EA01D

### TIG lastoorts SR-18 F met Highflex (HF) slangpakket en basis aansluiting

Positie	Artikelbeschrijving	Bestelnummer
	SR-18 F/4 m, Leder+Rubber, G-Cu-W, RTC-DD	84B1018204EA01D
	SR-18 F/8 m, Leder+Rubber, G-Cu-W, RTC-DD	84B1018208EA01D

### Onderdelen toortslichaam

Positie	Artikelbeschrijving	Bestelnummer
1a	Toortslichaam SR-18	85600180
1b	Toortslichaam SR-18 F Flexibel	85600182

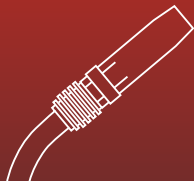
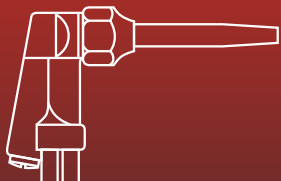

### TIG lastoorts SR-18 met Highflex-Weefsel beschermsslant (HFG) en basis aansluiting

Positie	Artikelbeschrijving	Bestelnummer
	SR-18/ 4 m, Leder+Weefsel Beschermsslant, G-Cu-W, RTC-DD	84F1018004EA01D
	SR-18/ 8 m, Leder+Weefsel Beschermsslant, G-Cu-W, RTC-DD	84F1018008EA01D
	SR-18/12 m, Leder+Weefsel Beschermsslant, G-Cu-W, RTC-DD	84F1018012EA01D
	SR-18/16 m, Leder+Weefsel Beschermsslant, G-Cu-W, RTC-DD	84F1018016EA01D

### TIG lastoorts SR-18 F met Highflex-Weefsel beschermsslant (HFG) en basis aansluiting

Positie	Artikelbeschrijving	Bestelnummer
	SR-18 F/ 4 m, Leder+Weefsel Beschermsslant, G-Cu-W, RTC-DD	84F1018204EA01D
	SR-18 F/ 8 m, Leder+Weefsel Beschermsslant, G-Cu-W, RTC-DD	84F1018208EA01D
	SR-18 F/12 m, Leder+Weefsel Beschermsslant, G-Cu-W, RTC-DD	84F1018212EA01D
	SR-18 F/16 m, Leder+Weefsel Beschermsslant, G-Cu-W, RTC-DD	84F1018216EA01D



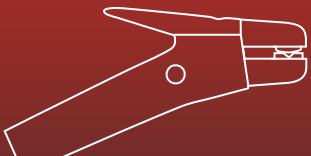

**ROHRMAN**  
SCHWEISSTECHNIK



**SR-18 SC**

**TIG handlastoorts SR-18 SC**

<b>Capaciteit bij 100% inschakelduur (10-min.-cyclus)</b>	<b>Koeling</b>	<b>Dia electrode</b>	<b>Norm</b>	<b>Aansluiting</b>
Gelijkstroom (DC) 400 A Wisselstroom (AC) 280 A	Waterkoeling	1,0-4,8 mm	EN 60 974-7	Passend voor iedere lasmaschine
			CE	

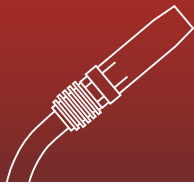
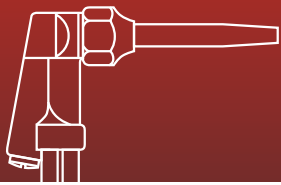

# SR-18 SC

400 A – DC – 100% ID

280 A – AC – 100% ID

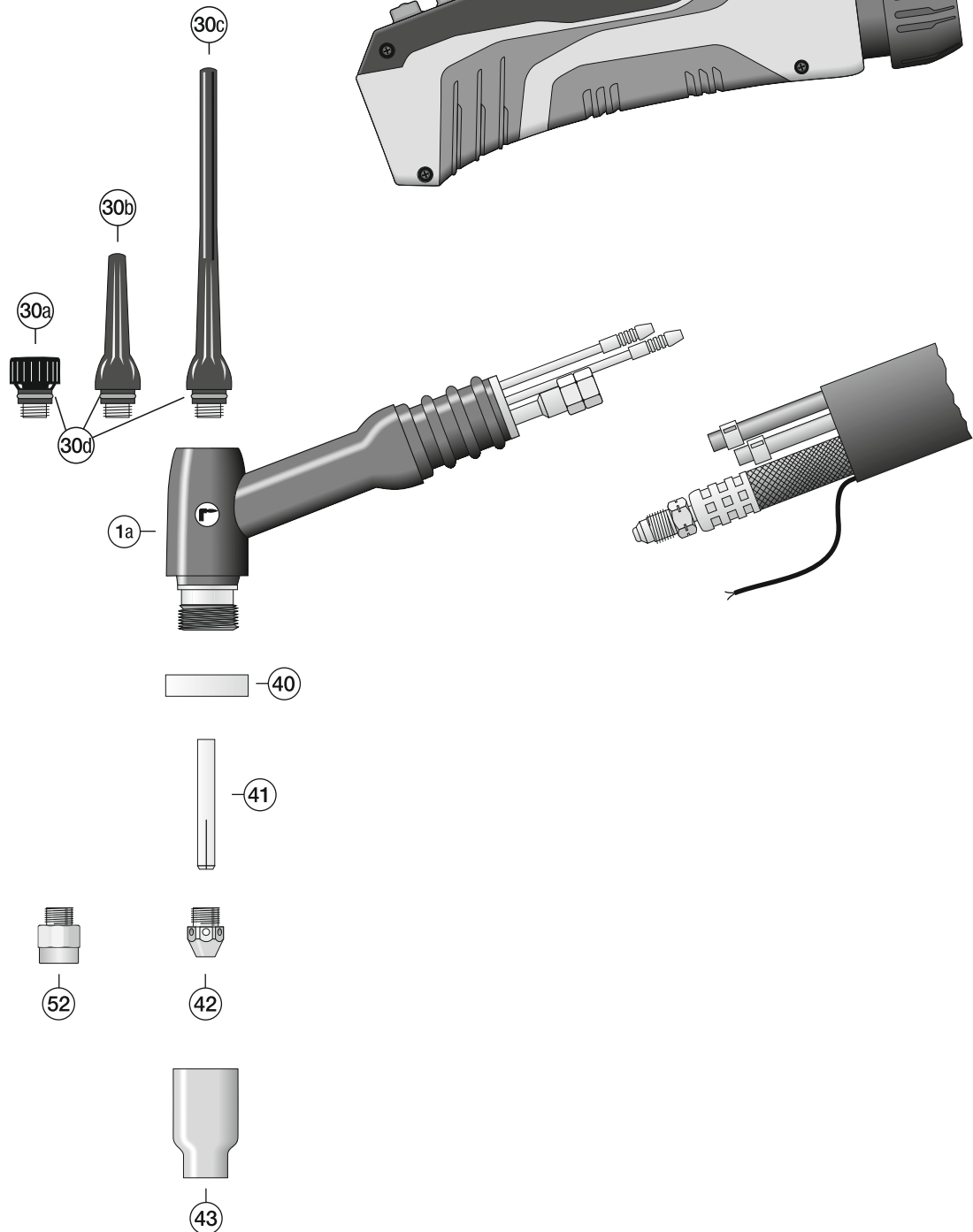

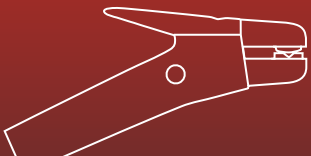

### TIG lastoorts SR-18 SC met Highflex (HF) slangpakket en basis aansluiting

Positie	Artikelbeschrijving	Bestelnummer
	SR-18 SC/4 m, Leder+Rubber, G-Cu-W, RTC-DD	84B1018C04EA01D
	SR-18 SC/8 m, Leder+Rubber, G-Cu-W, RTC-DD	84B1018C08EA01D

### Onderdelen toortslichaam

Positie	Artikelbeschrijving	Bestelnummer
1a	Toortslichaam SR-18 SC	8560018C

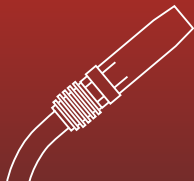
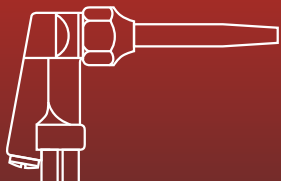

## TIG lastoorts SR-18 SC met Highflex-Weefsel bescherm slang (HFG) en basis aansluiting

Positie	Artikelbeschrijving	Bestelnummer
	SR-18 SC/ 4 m, Leder+Weefsel Bescherm slang, G-Cu-W, RTC-DD	84F1018C04EA01D
	SR-18 SC/ 8 m, Leder+Weefsel Bescherm slang, G-Cu-W, RTC-DD	84F1018C08EA01D
	SR-18 SC/12 m, Leder+Weefsel Bescherm slang, G-Cu-W, RTC-DD	84F1018C12EA01D
	SR-18 SC/16 m, Leder+Weefsel Bescherm slang, G-Cu-W, RTC-DD	84F1018C16EA01D

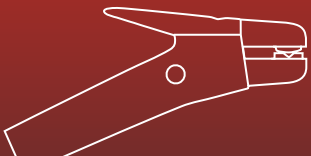

**ROHRMAN**  
SCHWEISSTECHNIK



**SR-20**



**SR-20 F3"**

**TIG handlastoorts SR-20, SR-20 F3", SR-20 F4"**

Capaciteit bij 100% inschakelduur (10-min.-cyclus)	Koeling	Dia elektrode	Norm	Aansluiting
Gelijkstroom (DC) 240 A Wisselstroom (AC) 170 A	Waterkoeling	0,5-3,2 mm	EN 60974-7 CE	Passend voor iedere lasmaschine



**SR-20 H**

**TIG handlastoorts SR-20 H**

Capaciteit bij 100% inschakelduur (10-min.-cyclus)	Koeling	Dia elektrode	Norm	Aansluiting
Gelijkstroom (DC) 270 A Wisselstroom (AC) 190 A	Waterkoeling	0,5-3,2 mm	EN 60974-7 CE	Passend voor iedere lasmaschine

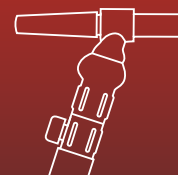
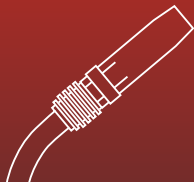
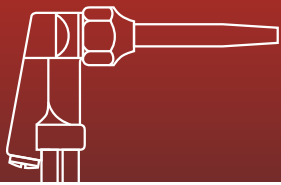

## SR-20/F

240 A - DC - 100% ID

170 A - AC - 100% ID

## SR-20 H

270 A - DC - 100% ID

190 A - AC - 100% ID

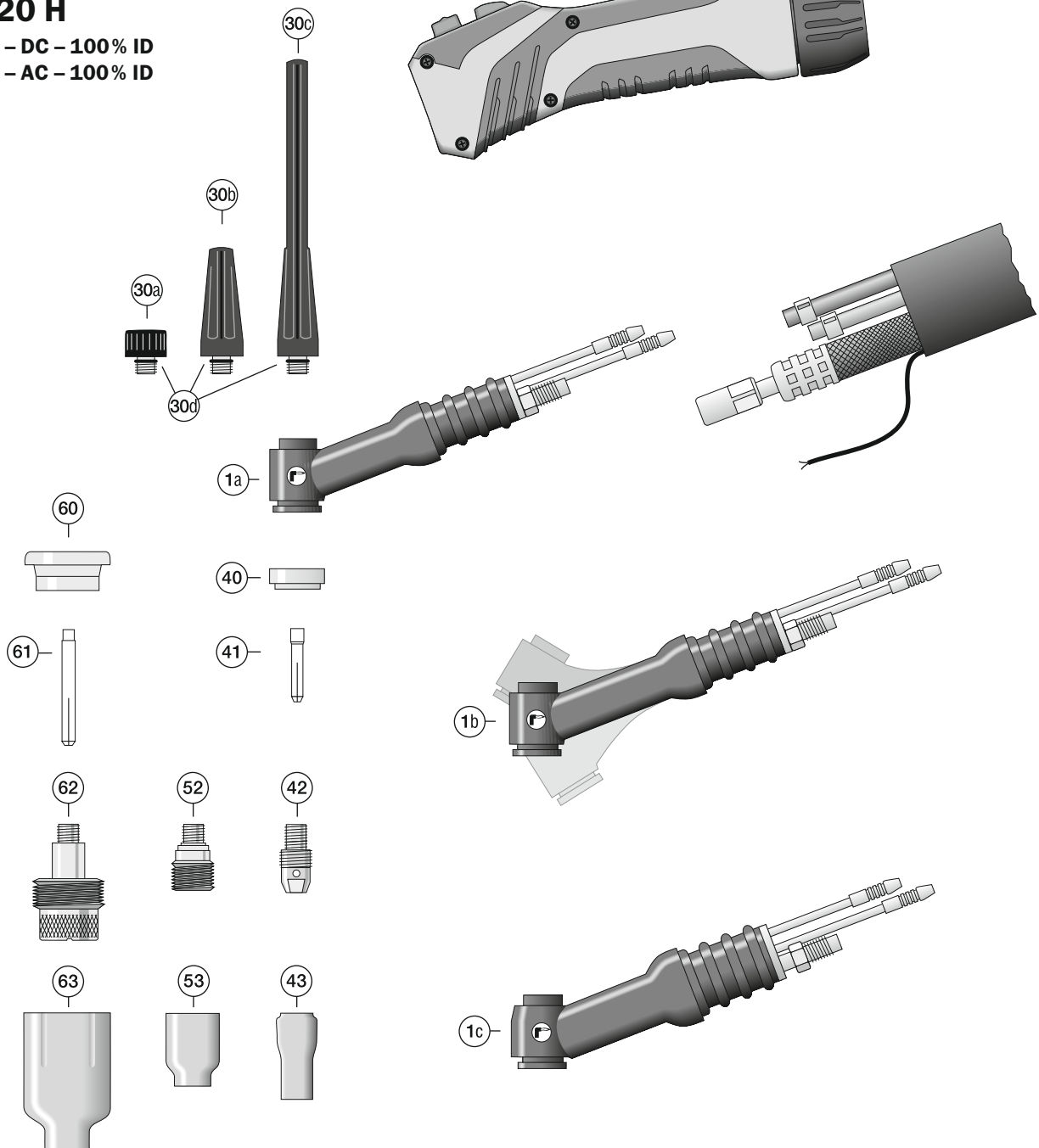

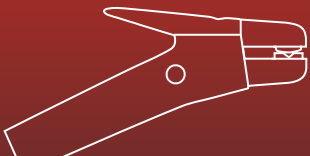

### TIG lastoorts SR-20 met Highflex (HF) slangpakket en basis aansluiting

Positie	Artikelbeschrijving	Bestelnummer
	SR-20/4 m, Leder+Rubber, G-Cu-W, RTC-DD	84B1020004EA01D
	SR-20/8 m, Leder+Rubber, G-Cu-W, RTC-DD	84B1020008EA01D

### TIG lastoorts SR-20 F met Highflex (HF) slangpakket en basis aansluiting

Positie	Artikelbeschrijving	Bestelnummer
	SR-20 F/4 m, Leder+Rubber, G-Cu-W, RTC-DD	84B1020204EA01D
	SR-20 F/8 m, Leder+Rubber, G-Cu-W, RTC-DD	84B1020208EA01D

### TIG lastoorts SR-20 F3" met Highflex (HF) slangpakket en basis aansluiting

Positie	Artikelbeschrijving	Bestelnummer
	SR-20 F3"/4 m, Leder+Rubber, G-Cu-W, RTC-DD	84B1020304EA01D
	SR-20 F3"/8 m, Leder+Rubber, G-Cu-W, RTC-DD	84B1020308EA01D

### TIG lastoorts SR-20 F4" met Highflex (HF) slangpakket en basis aansluiting

Positie	Artikelbeschrijving	Bestelnummer
	SR-20 F4"/4 m, Leder+Rubber, G-Cu-W, RTC-DD	84B1020404EA01D
	SR-20 F4"/8 m, Leder+Rubber, G-Cu-W, RTC-DD	84B1020408EA01D

### TIG lastoorts SR-20 F5" met Highflex (HF) slangpakket en basis aansluiting

Positie	Artikelbeschrijving	Bestelnummer
	SR-20 F5"/4 m, Leder+Rubber, G-Cu-W, RTC-DD	84B1020504EA01D
	SR-20 F5"/8 m, Leder+Rubber, G-Cu-W, RTC-DD	84B1020508EA01D

### TIG lastoorts SR-20 H met Highflex (HF) slangpakket en basis aansluiting

Positie	Artikelbeschrijving	Bestelnummer
	SR-20 H/4 m, Leder+Rubber, G-Cu-W, RTC-DD	84B1020H04EA01D
	SR-20 H/8 m, Leder+Rubber, G-Cu-W, RTC-DD	84B1020H08EA01D

### Onderdelen toortslichaam

Positie	Artikelbeschrijving	Bestelnummer
1a	Toortslichaam SR-20	85600200
1b	Toortslichaam SR-20 F Flexibel	85600202
	Toortslichaam SR-20 F3" (75 mm) Flexibel	85600203
	Toortslichaam SR-20 F4" (100 mm) Flexibel	85600204
	Toortslichaam SR-20 F5" (125 mm) Flexibel	85600205
1c	Toortslichaam SR-20 H	8560020H

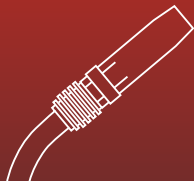
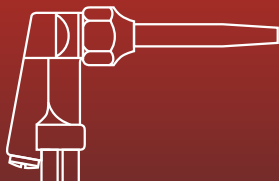

### TIG lastoorts SR-20 met Highflex-Weefsel bescherm slang (HFG) en basis aansluiting

Positie	Artikelbeschrijving	Bestelnummer
	SR-20/ 4 m, Leder+Weefsel Bescherm slang, G-Cu-W, RTC-DD	84F1020004EA01D
	SR-20/ 8 m, Leder+Weefsel Bescherm slang, G-Cu-W, RTC-DD	84F1020008EA01D
	SR-20/12 m, Leder+Weefsel Bescherm slang, G-Cu-W, RTC-DD	84F1020012EA01D
	SR-20/16 m, Leder+Weefsel Bescherm slang, G-Cu-W, RTC-DD	84F1020016EA01D

### TIG lastoorts SR-20 F met Highflex-Weefsel bescherm slang (HFG) en basis aansluiting

Positie	Artikelbeschrijving	Bestelnummer
	SR-20 F/ 4 m, Leder+Weefsel Bescherm slang, G-Cu-W, RTC-DD	84F1020204EA01D
	SR-20 F/ 8 m, Leder+Weefsel Bescherm slang, G-Cu-W, RTC-DD	84F1020208EA01D
	SR-20 F/12 m, Leder+Weefsel Bescherm slang, G-Cu-W, RTC-DD	84F1020212EA01D
	SR-20 F/16 m, Leder+Weefsel Bescherm slang, G-Cu-W, RTC-DD	84F1020216EA01D

### TIG lastoorts SR-20 F3" met Highflex-Weefsel bescherm slang (HFG) en basis aansluiting

Positie	Artikelbeschrijving	Bestelnummer
	SR-20 F3"/ 4 m, Leder+Weefsel Bescherm slang, G-Cu-W, RTC-DD	84F1020304EA01D
	SR-20 F3"/ 8 m, Leder+Weefsel Bescherm slang, G-Cu-W, RTC-DD	84F1020308EA01D
	SR-20 F3"/12 m, Leder+Weefsel Bescherm slang, G-Cu-W, RTC-DD	84F1020312EA01D
	SR-20 F3"/16 m, Leder+Weefsel Bescherm slang, G-Cu-W, RTC-DD	84F1020316EA01D

### TIG lastoorts SR-20 F4" met Highflex-Weefsel bescherm slang (HFG) en basis aansluiting

Positie	Artikelbeschrijving	Bestelnummer
	SR-20 F4"/ 4 m, Leder+Weefsel Bescherm slang, G-Cu-W, RTC-DD	84F1020404EA01D
	SR-20 F4"/ 8 m, Leder+Weefsel Bescherm slang, G-Cu-W, RTC-DD	84F1020408EA01D
	SR-20 F4"/12 m, Leder+Weefsel Bescherm slang, G-Cu-W, RTC-DD	84F1020412EA01D
	SR-20 F4"/16 m, Leder+Weefsel Bescherm slang, G-Cu-W, RTC-DD	84F1020416EA01D

### TIG lastoorts SR-20 F5" met Highflex-Weefsel bescherm slang (HFG) en basis aansluiting

Positie	Artikelbeschrijving	Bestelnummer
	SR-20 F5"/ 4 m, Leder+Weefsel Bescherm slang, G-Cu-W, RTC-DD	84F1020504EA01D
	SR-20 F5"/ 8 m, Leder+Weefsel Bescherm slang, G-Cu-W, RTC-DD	84F1020508EA01D
	SR-20 F5"/12 m, Leder+Weefsel Bescherm slang, G-Cu-W, RTC-DD	84F1020512EA01D
	SR-20 F5"/16 m, Leder+Weefsel Bescherm slang, G-Cu-W, RTC-DD	84F1020516EA01D

### TIG lastoorts SR-20 H met Highflex-Weefsel bescherm slang (HFG) en basis aansluiting

Positie	Artikelbeschrijving	Bestelnummer
	SR-20 H/ 4 m, Leder+Weefsel Bescherm slang, G-Cu-W, RTC-DD	84F1020H04EA01D
	SR-20 H/ 8 m, Leder+Weefsel Bescherm slang, G-Cu-W, RTC-DD	84F1020H08EA01D
	SR-20 H/12 m, Leder+Weefsel Bescherm slang, G-Cu-W, RTC-DD	84F1020H12EA01D
	SR-20 H/16 m, Leder+Weefsel Bescherm slang, G-Cu-W, RTC-DD	84F1020H16EA01D



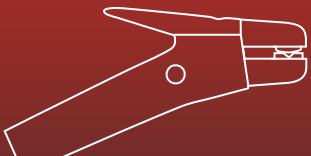

**ROHRMAN**  
SCHWEISSTECHNIK



**SR-24 G**

**TIG handlastoorts SR-24 G**

<b>Capaciteit bij 35% inschakelduur (10-min.-cyclus)</b>	<b>Koeling</b>	<b>Dia electrode</b>	<b>Norm</b>	<b>Aansluiting</b>
Gelijkstroom (DC) 110 A Wisselstroom (AC) 75 A	Luchtkoeling	0,5–1,6 mm	EN 60 974-7	Passend voor iedere lasmaschine
			CE	

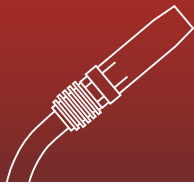
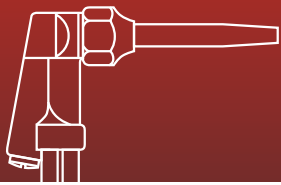

## SR-24 G

110 A - DC - 35% ID

75 A - AC - 35% ID

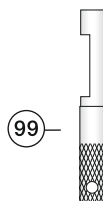
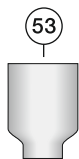
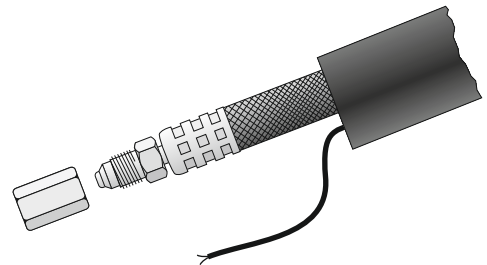
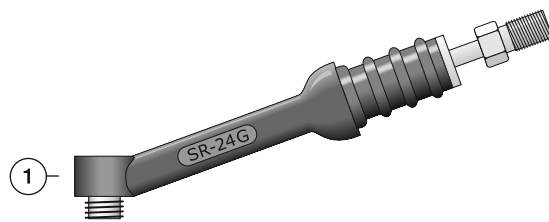
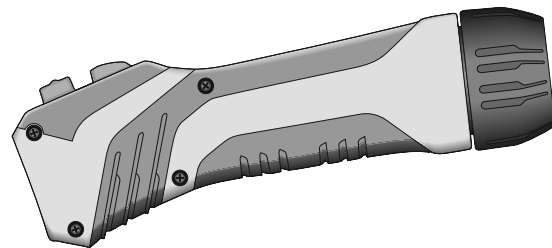

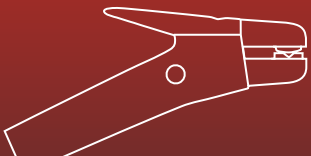

### TIG lastoorts SR-24 G met Highflex (HF) slangpakket en basis aansluiting

Positie	Artikelbeschrijving	Bestelnummer
	SR-24 G/4 m, Leder+Rubber, G-Cu-W, RTC-DD	84B1024G04EB01D
	SR-24 G/8 m, Leder+Rubber, G-Cu-W, RTC-DD	84B1024G08EB01D

### Onderdelen toortslichaam

Positie	Artikelbeschrijving	Bestelnummer
1	Toortslichaam SR-24 G	8560024G

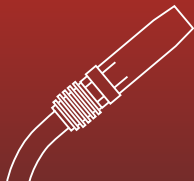
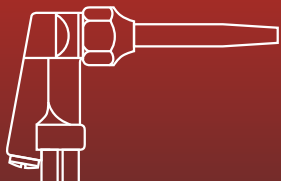

## TIG lastoorts SR-24 G met Highflex-Weefsel beschermsslant (HFG) en basis aansluiting

Positie	Artikelbeschrijving	Bestelnummer
	SR-24 G/ 4 m, Leder+Weefsel Beschermsslant, G-Cu-W, RTC-DD	84F1024G04EB01D
	SR-24 G/ 8 m, Leder+Weefsel Beschermsslant, G-Cu-W, RTC-DD	84F1024G08EB01D
	SR-24 G/12 m, Leder+Weefsel Beschermsslant, G-Cu-W, RTC-DD	84F1024G12EB01D
	SR-24 G/16 m, Leder+Weefsel Beschermsslant, G-Cu-W, RTC-DD	84F1024G16EB01D

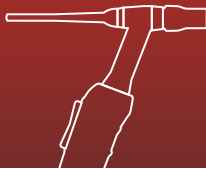
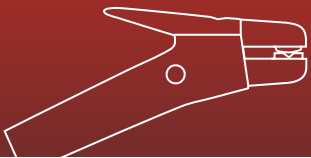

**ROHRMAN**  
SCHWEISSTECHNIK



**SR-24 W**

**TIG handlastoorts SR-24 W**

<b>Capaciteit bij 100% inschakelduur (10-min.-cyclus)</b>	<b>Koeling</b>	<b>Dia electrode</b>	<b>Norm</b>	<b>Aansluiting</b>
Gelijkstroom (DC) 180 A Wisselstroom (AC) 125 A	Waterkoeling	0,5–2,4 mm	EN 60 974-7	Passend voor iedere lasmaschine
			CE	

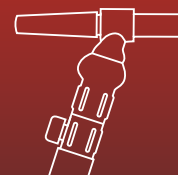
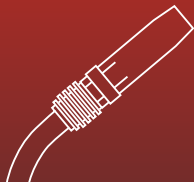
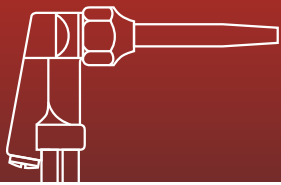

## SR-24 W

180 A - DC - 100% ID

125 A - AC - 100% ID

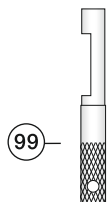
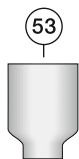
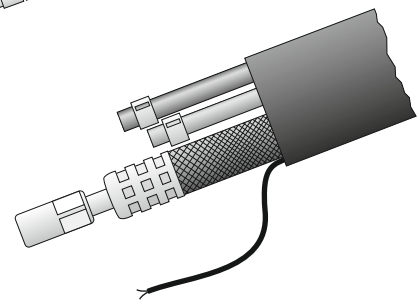
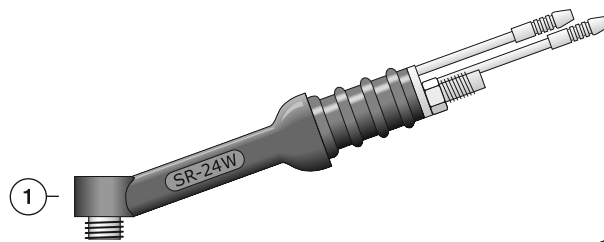
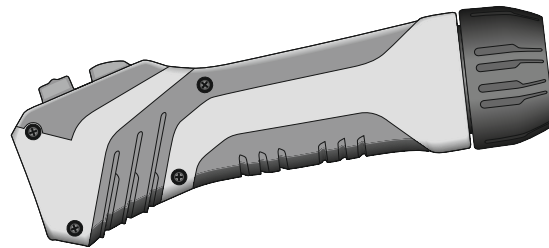

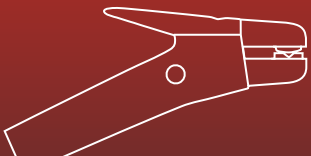

### TIG lastoorts SR-24 W met Highflex (HF) slangpakket en basis aansluiting

Positie	Artikelbeschrijving	Bestelnummer
	SR-24 W/4 m, Leder+Rubber, G-Cu-W, RTC-DD	84B1024W04EA01D
	SR-24 W/8 m, Leder+Rubber, G-Cu-W, RTC-DD	84B1024W08EA01D

### Onderdelen toortslichaam

Positie	Artikelbeschrijving	Bestelnummer
1	Toortslichaam SR-24 W	8560024W

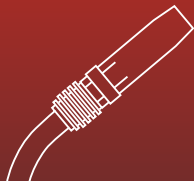
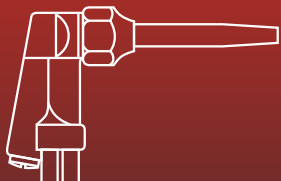

### TIG lastoorts SR-24 W met Highflex-Weefsel beschermsslant (HFG) en basis aansluiting

Positie	Artikelbeschrijving	Bestelnummer
	SR-24 W/ 4 m, Leder+Weefsel Beschermsslant, G-Cu-W, RTC-DD	84F1024W04EA01D
	SR-24 W/ 8 m, Leder+Weefsel Beschermsslant, G-Cu-W, RTC-DD	84F1024W08EA01D
	SR-24 W/12 m, Leder+Weefsel Beschermsslant, G-Cu-W, RTC-DD	84F1024W12EA01D
	SR-24 W/16 m, Leder+Weefsel Beschermsslant, G-Cu-W, RTC-DD	84F1024W16EA01D



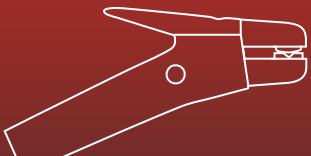

**ROHRMAN**  
SCHWEISSTECHNIK



**SR-26**



**SR-26 V**

**TIG handlastoorts SR-26, SR-26 V**

Capaciteit bij 35% inschakelduur (10-min.-cyclus)	Koeling	Dia electrode	Norm	Aansluiting
Gelijkstroom (DC) 200 A Wisselstroom (AC) 140 A	Luchtkoeling	0,5–3,2 mm	EN 60974-7 CE	Passend voor iedere lasmaschine

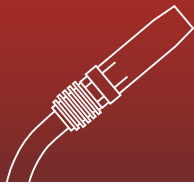
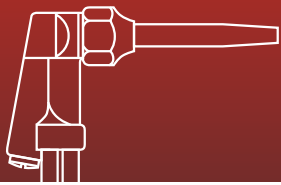

# SR-26/F/V

200 A - DC - 35% ID  
140 A - AC - 35% ID

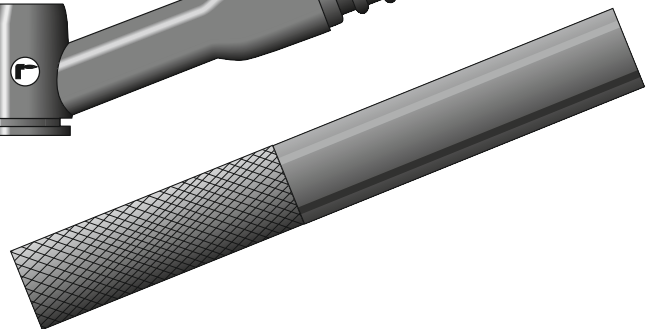
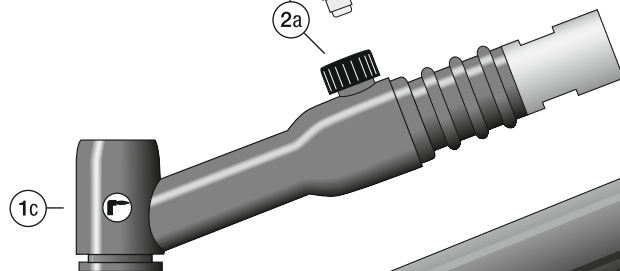
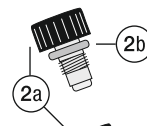
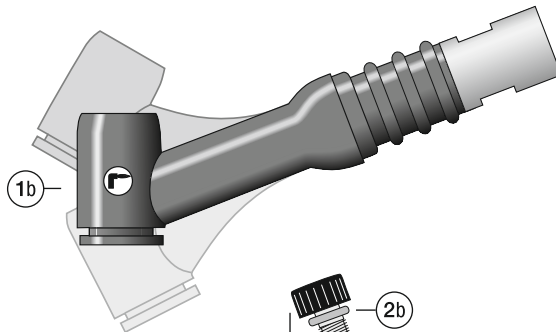
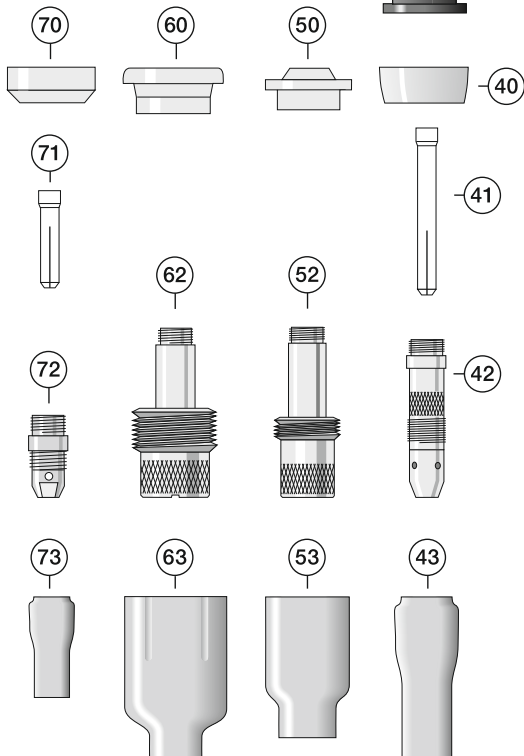
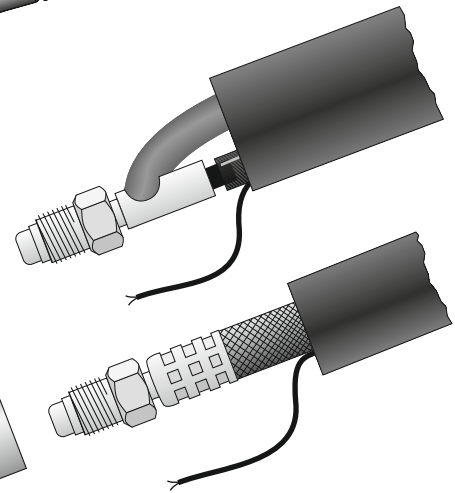
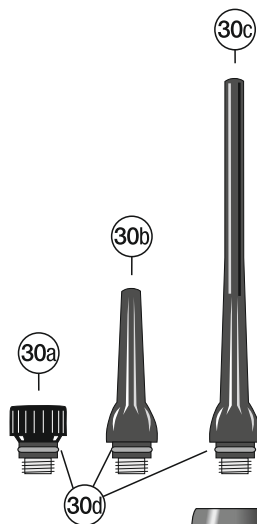
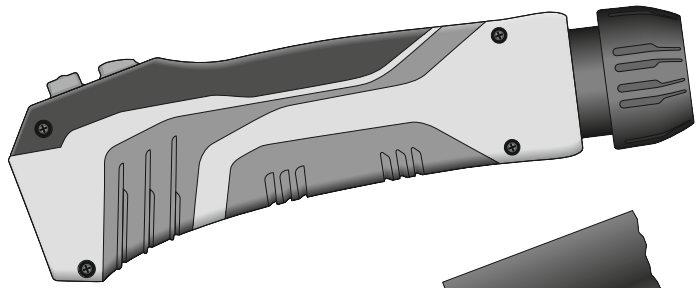



### TIG lastoorts SR-26 met Highflex (HF) slangpakket en basis aansluiting

Positie	Artikelbeschrijving	Bestelnummer
	SR-26/4 m, Leder+Rubber, G-Cu-W, RTC-DD	84B1026004EB01D
	SR-26/8 m, Leder+Rubber, G-Cu-W, RTC-DD	84B1026008EB01D

### TIG lastoorts SR-26 F met Highflex (HF) slangpakket en basis aansluiting

Positie	Artikelbeschrijving	Bestelnummer
	SR-26 F/4 m, Leder+Rubber, G-Cu-W, RTC-DD	84B1026204EB01D
	SR-26 F/8 m, Leder+Rubber, G-Cu-W, RTC-DD	84B1026208EB01D

### TIG lastoorts SR-26 V met stroom-/gaskabel en basis aansluiting

Positie	Artikelbeschrijving	Bestelnummer
	SR-26 V/4 m, T-Cu, Handgreep Rond	8407026V04E030
	SR-26 V/8 m, T-Cu, Handgreep Rond	8407026V08E030

### TIG lastoorts SR-26 FV met stroom-/gaskabel en basis aansluiting

Positie	Artikelbeschrijving	Bestelnummer
	SR-26 FV/4 m, T-Cu, Handgreep Rond	8407026Y04E030
	SR-26 FV/8 m, T-Cu, Handgreep Rond	8407026Y08E030

### Onderdelen toortslichaam

Positie	Artikelbeschrijving	Bestelnummer
1a	Toortslichaam SR-26	85600260
1b	Toortslichaam SR-26 F Flexibel	85600262
1c	Toortslichaam SR-26 V Met Draaiventil Knop	8560026V
	Toortslichaam SR-26 FV Flexibel En Met Draaiventil Knop	8560026Y
2a	Draaiventil Knop Voor SR-26 V	85511001
2b	O-Ring Voor Draaiventil Knop	85509008

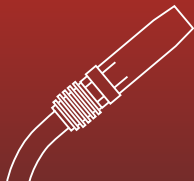
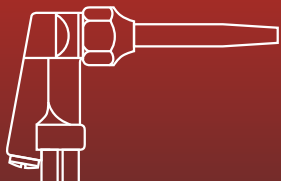

### TIG lastoorts SR-26 met Highflex-Weefsel beschermsslant (HFG) en basis aansluiting

Positie	Artikelbeschrijving	Bestelnummer
	SR-26/ 4 m, Leder+Weefsel Beschermsslant, G-Cu-W, RTC-DD	84F1026004EB01D
	SR-26/ 8 m, Leder+Weefsel Beschermsslant, G-Cu-W, RTC-DD	84F1026008EB01D
	SR-26/12 m, Leder+Weefsel Beschermsslant, G-Cu-W, RTC-DD	84F1026012EB01D
	SR-26/16 m, Leder+Weefsel Beschermsslant, G-Cu-W, RTC-DD	84F1026016EB01D

### TIG lastoorts SR-26 F met Highflex-Weefsel beschermsslant (HFG) en basis aansluiting

Positie	Artikelbeschrijving	Bestelnummer
	SR-26 F/ 4 m, Leder+Weefsel Beschermsslant, G-Cu-W, RTC-DD	84F1026204EB01D
	SR-26 F/ 8 m, Leder+Weefsel Beschermsslant, G-Cu-W, RTC-DD	84F1026208EB01D
	SR-26 F/12 m, Leder+Weefsel Beschermsslant, G-Cu-W, RTC-DD	84F1026212EB01D
	SR-26 F/16 m, Leder+Weefsel Beschermsslant, G-Cu-W, RTC-DD	84F1026216EB01D

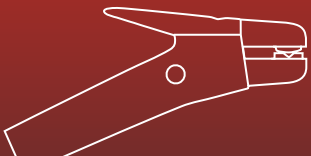

**ROHRMAN**  
SCHWEISSTECHNIK



**TIG Handgriep RTC**  
*Rohrman TIG Comfort*



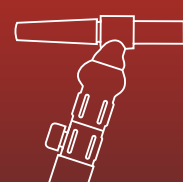
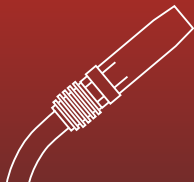
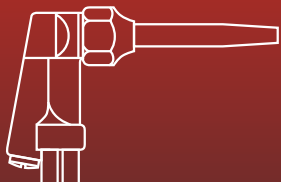

# TIG Handgrip RTC

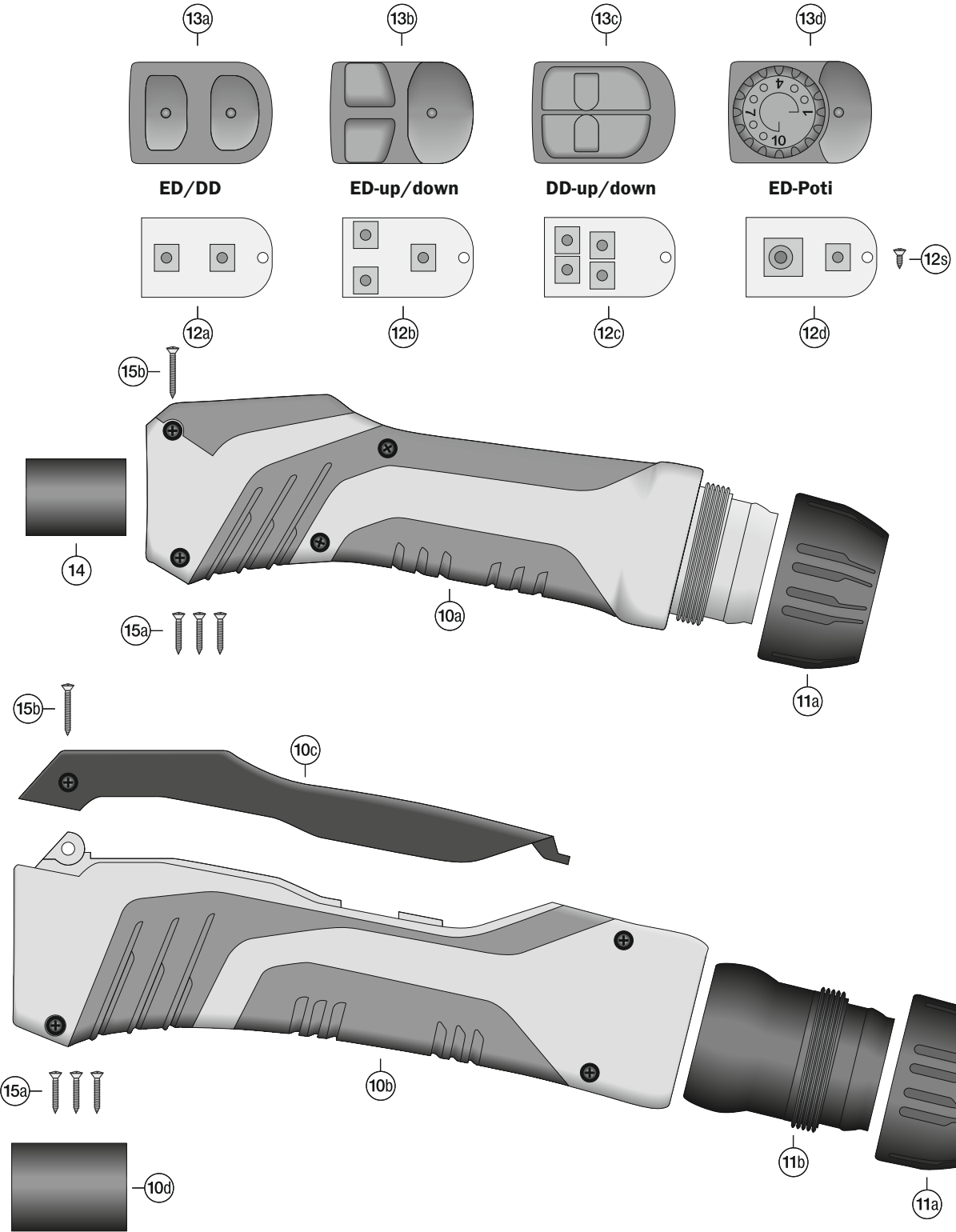

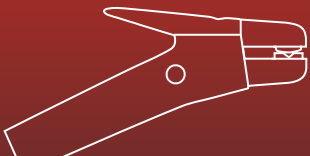
**Onderdelen Handgreep RTC**

<b>Positie</b>	<b>Artikelbeschrijving</b>		<b>Bestelnummer</b>
	Set Handgreep Klein ED/DD Zwart	(9/17/20/24)	85503011D10-SW1
	Set Handgreep Klein ED-UpDown Zwart	(9/17/20/24)	85503011V10-SW1
	Set Handgreep Klein DD-UpDown Zwart	(9/17/20/24)	85503011U10-SW1
	Set Handgreep Klein ED-Poti 10k Zwart	(9/17/20/24)	85503011Q10-SW1
	Set Handgreep Klein ED/DD Rood	(9/17/20/24)	85503011D10-RT1
	Set Handgreep Klein ED-UpDown Rood	(9/17/20/24)	85503011V10-RT1
	Set Handgreep Klein DD-UpDown Rood	(9/17/20/24)	85503011U10-RT1
	Set Handgreep Klein ED-Poti 10k Rood	(9/17/20/24)	85503011Q10-RT1
	Set Handgreep Groot ED/DD Zwart	(18/18SC/26)	85503012D10-SW1
	Set Handgreep Groot ED-UpDown Zwart	(18/18SC/26)	85503012V10-SW1
	Set Handgreep Groot DD-UpDown Zwart	(18/18SC/26)	85503012U10-SW1
	Set Handgreep Groot ED-Poti 10k Zwart	(18/18SC/26)	85503012Q10-SW1
	Set Handgreep Groot ED/DD Rood	(18/18SC/26)	85503012D10-RT1
	Set Handgreep Groot ED-UpDown Rood	(18/18SC/26)	85503012V10-RT1
	Set Handgreep Groot DD-UpDown Rood	(18/18SC/26)	85503012U10-RT1
	Set Handgreep Groot ED-Poti 10k Rood	(18/18SC/26)	85503012Q10-RT1
10a	Handgreep Paar Schalen Klein (li+re) Zwart		8550301Z1-1SW00
	Handgreep Paar Schalen Klein (li+re) Rood		8550301Z1-1RT00
	Handgreep Paar Schalen Klein (li+re) Blauw		8550301Z1-1BL00
10b	Handgreep Paar Schalen Groot (li+re) Zwart		8550301Z1-2SW00
	Handgreep Paar Schalen Groot (li+re) Rood		8550301Z1-2RT00
	Handgreep Paar Schalen Groot (li+re) Blauw		8550301Z1-2BL00
10c	Tap		8550301Z1-3SW
	Adapter Toortslichaam v4	(18/18SC/26)	8550301Z3-21
10d	Reduktie Mof (Handgreep Groot Op Klein )		8550301Z3-20
11a	Dichtings Moer		8550301Z2-4SW
11b	Kogelgewricht		8550301Z2-2SW
12a	Platine ED/DD		8550301Z5-1201
12b	Platine ED-UpDown		8550301Z5-1611
12c	Platine DD-UpDown		8550301Z5-1311
12d	Platine ED-Poti 10 kΩ		8550301Z5-1411-40
	Platine ED-Poti 1 kΩ		8550301Z5-1411-41
	Platine ED-Poti 4,7 kΩ (5,0 kΩ)		8550301Z5-1411-42
	Platine ED-Poti 47 kΩ (50 kΩ)		8550301Z5-1411-43
12s	Schroef Voor Platine (Greep Groot)		8550301Z5-91
13a	Platine ED/DD		8550301Z4-1200GR
13b	Platine ED-UpDown		8550301Z4-1610GR
13c	Platine DD-UpDown (Onderdelen Set)		8550301Z4-1315GR
13d	Platine ED-Poti (Onderdelen Set)		8550301Z4-1415GR
14	Adapter Toortslichaam v1	(9/17/20/24)	8550301Z3-11
	Adapter Toortslichaam v2		8550301Z3-13
	Adapter Toortslichaam v3 (2 pc)		8550301Z3-14
	<i>voor kleine handgreep, in verbinding met 10d ook voor grote handgreep</i>		
15a	Schroef L=13 mm		8550301Z1-91
15b	Schroef L=19 mm		8550301Z1-92

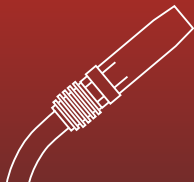
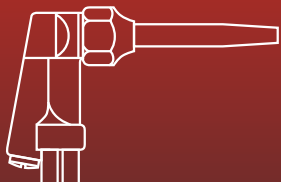

## Notities

A large rectangular area with horizontal grey lines, serving as a template for notes or text.



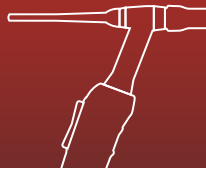

## Slangpakketten



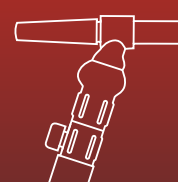
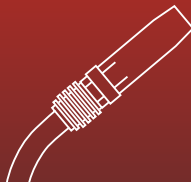
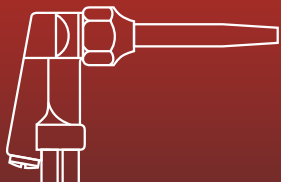

## Slangpakketten

### SR-9/17/24 G

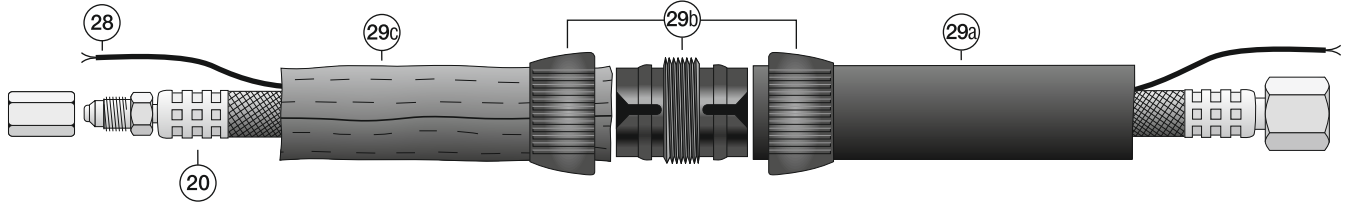

**3/8"-24 UNF rechts, buitendraad draaibaar (AD)  
+ Adapter**

**G<sup>1</sup>/<sub>4</sub>" rechts, wartel (ÜM)**

### SR-26

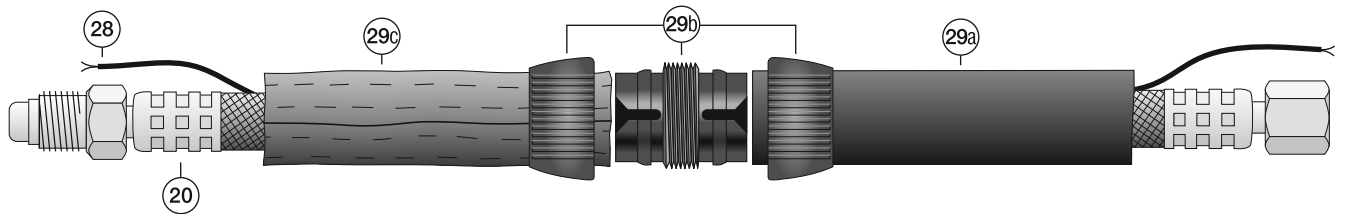

**5/8"-18 UNF rechts, buitendraad draaibaar (AD)**

**G<sup>1</sup>/<sub>4</sub>" rechts, wartel (ÜM)**

### SR-20/24 W

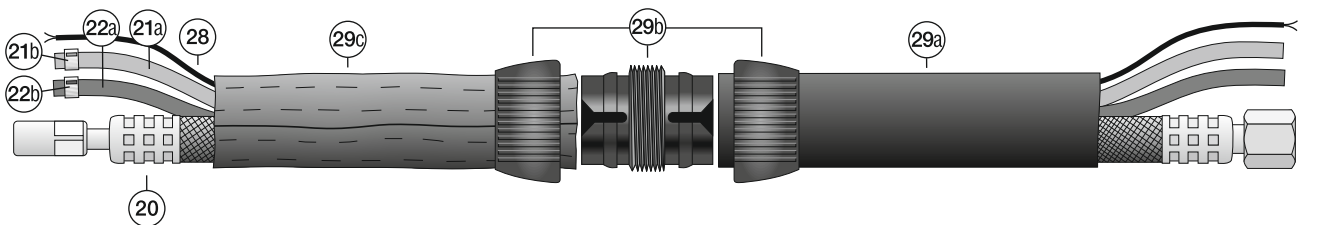

**1/4"-28 UNF rechts, wartel (ÜM)**

**M12x1 rechts, wartel (ÜM)**

### SR-18/18 SC

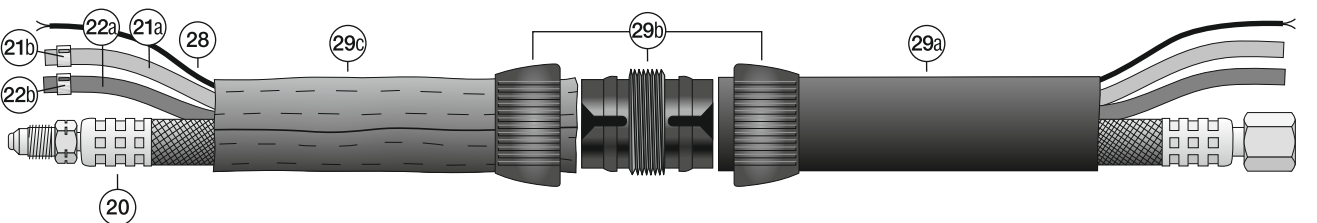

**3/8"-24 UNF links, buitendraad draaibaar (AD)**

**M12x1 rechts, wartel (ÜM)**

**Onderdelen voor slangpakketten**

<b>Positie</b>	<b>Artikelbeschrijving</b>	<b>Bestelnummer</b>
20	Stroomkabel/ 4 m, Rubber, Litze-Cu, SR-9	821009004G1/4#
	Stroomkabel/ 8 m, Rubber, Litze-Cu, SR-9	821009008G1/4#
	Stroomkabel/12 m, Rubber, Litze-Cu, SR-9	821009012G1/4#
	Stroomkabel/16 m, Rubber, Litze-Cu, SR-9	821009016G1/4#
20	Stroomkabel/ 4 m, Rubber, Litze-Cu, SR-17	821017004G1/4#
	Stroomkabel/ 8 m, Rubber, Litze-Cu, SR-17	821017008G1/4#
	Stroomkabel/12 m, Rubber, Litze-Cu, SR-17	821017012G1/4#
	Stroomkabel/16 m, Rubber, Litze-Cu, SR-17	821017016G1/4#
20	Stroomkabel/ 4 m, Rubber, Litze-Cu, SR-24 G	821024G04G1/4#
	Stroomkabel/ 8 m, Rubber, Litze-Cu, SR-24 G	821024G08G1/4#
	Stroomkabel/12 m, Rubber, Litze-Cu, SR-24 G	821024G12G1/4#
	Stroomkabel/16 m, Rubber, Litze-Cu, SR-24 G	821024G16G1/4#
20	Stroomkabel/ 4 m, Rubber, Litze-Cu, SR-26	821026004G1/4#
	Stroomkabel/ 8 m, Rubber, Litze-Cu, SR-26	821026008G1/4#
	Stroomkabel/12 m, Rubber, Litze-Cu, SR-26	821026012G1/4#
	Stroomkabel/16 m, Rubber, Litze-Cu, SR-26	821026016G1/4#
20	Stroomkabel/ 4 m, Rubber, Litze-Cu, SR-20/24 W	821020004M12X1#
	Stroomkabel/ 8 m, Rubber, Litze-Cu, SR-20/24 W	821020008M12X1#
	Stroomkabel/12 m, Rubber, Litze-Cu, SR-20/24 W	821020012M12X1#
	Stroomkabel/16 m, Rubber, Litze-Cu, SR-20/24 W	821020016M12X1#
20	Stroomkabel/ 4 m, Rubber, Litze-Cu, SR-20 H	821020H04M12X1#
	Stroomkabel/ 8 m, Rubber, Litze-Cu, SR-20 H	821020H08M12X1#
	Stroomkabel/12 m, Rubber, Litze-Cu, SR-20 H	821020H12M12X1#
	Stroomkabel/16 m, Rubber, Litze-Cu, SR-20 H	821020H16M12X1#
20	Stroomkabel/ 4 m, Rubber, Litze-Cu, SR-18	821018004M12x1#
	Stroomkabel/ 8 m, Rubber, Litze-Cu, SR-18	821018008M12X1#
	Stroomkabel/12 m, Rubber, Litze-Cu, SR-18	821018012M12X1#
	Stroomkabel/16 m, Rubber, Litze-Cu, SR-18	821018016M12x1#
20	Stroomkabel/ 4 m, Rubber, Litze-Cu, SR-18 SC	821018C04M12X1#
	Stroomkabel/ 8 m, Rubber, Litze-Cu, SR-18 SC	821018C08M12X1#
	Stroomkabel/12 m, Rubber, Litze-Cu, SR-18 SC	821018C12M12X1#
	Stroomkabel/16 m, Rubber, Litze-Cu, SR-18 SC	821018C16M12X1#
21a	Slang Rubber 5x8 Blauw – Rol 100 m	855130508B
21b	Eenoor Klem Met Inlegring 9,5	855200095
22a	Slang Rubber 5x8 Zwart – Rol 100 m	855130508S
22b	Eenoor Klem Met Inlegring 9,5	855200095
22a	Slang Rubber 4x6 Zwart – Rol 100 m	855130406S
22b	Eenoor Klem Met Inlegring 8,7	855200087
28	Stuurkabel 3-Fasen – Rol 100 m	855180103034FD
	Stuurkabel 7-Fasen – Rol 100 m	855180107025FD
	Stuurkabel 3-Fasen Afgeschermt – Rol 100 m	855180203034
	Stuurkabel 6-Fasen Afgeschermt – Rol 100 m	855180206034
29a	Beschermslang Rubber Ø 23 mm – Rol 50 m	8551402310
	Beschermslang Rubber Ø 26 mm – Rol 50 m	8551402610
	Beschermslang Weefsel Ø 22 mm – Rol 40 m	85514122
	Beschermslang Weefsel Ø 25 mm – Rol 40 m	85514125
29b	Verbindingshuls	8551002001
29c	Beschermslang/1 m Leder Ø 22 mm	85514Z0222
	Beschermslang/1 m Leder Ø 28 mm	85514Z0228

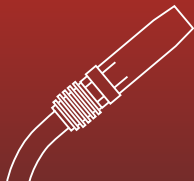
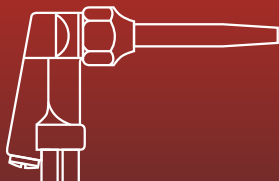

## Slangpakketten HF (Highflex Rubber)

Positie	Artikelbeschrijving	Bestelnummer
	Pakket/4 m, Leder+Rubber, G-Cu-W, SR-9	83B1009004G1/4#
	Pakket/8 m, Leder+Rubber, G-Cu-W, SR-9	83B1009008G1/4#
	Pakket/4 m, Leder+Rubber, G-Cu-W, SR-17	83B1017004G1/4#
	Pakket/8 m, Leder+Rubber, G-Cu-W, SR-17	83B1017008G1/4#
	Pakket/4 m, Leder+Rubber, G-Cu-W, SR-24 G	83B1024G04G1/4#
	Pakket/8 m, Leder+Rubber, G-Cu-W, SR-24 G	83B1024G08G1/4#
	Pakket/4 m, Leder+Rubber, G-Cu-W, SR-26	83B1026004G1/4#
	Pakket/8 m, Leder+Rubber, G-Cu-W, SR-26	83B1026008G1/4#
	Pakket/4 m, Leder+Rubber, G-Cu-W, SR-20/24 W	83B1020004M12X1#
	Pakket/8 m, Leder+Rubber, G-Cu-W, SR-20/24 W	83B1020008M12X1#
	Pakket/4 m, Leder+Rubber, G-Cu-W, SR-20 H	83B1020H04M12X1#
	Pakket/8 m, Leder+Rubber, G-Cu-W, SR-20 H	83B1020H08M12X1#
	Pakket/4 m, Leder+Rubber, G-Cu-W, SR-18	83B1018004M12X1#
	Pakket/8 m, Leder+Rubber, G-Cu-W, SR-18	83B1018008M12X1#
	Pakket/4 m, Leder+Rubber, G-Cu-W, SR-18 SC	83B1018C04M12X1#
	Pakket/8 m, Leder+Rubber, G-Cu-W, SR-18 SC	83B1018C08M12X1#

## Slangpakketten HFG (Highflex Weefsel)

Positie	Artikelbeschrijving	Bestelnummer
	Pakket/ 4 m, Leder+Weefsel Beschermslang, G-Cu-W, SR-9	83F1009004G1/4#
	Pakket/ 8 m, Leder+Weefsel Beschermslang, G-Cu-W, SR-9	83F1009008G1/4#
	Pakket/12 m, Leder+Weefsel Beschermslang, G-Cu-W, SR-9	83F1009012G1/4#
	Pakket/16 m, Leder+Weefsel Beschermslang, G-Cu-W, SR-9	83F1009016G1/4#
	Pakket/ 4 m, Leder+Weefsel Beschermslang, G-Cu-W, SR-17	83F1017004G1/4#
	Pakket/ 8 m, Leder+Weefsel Beschermslang, G-Cu-W, SR-17	83F1017008G1/4#
	Pakket/12 m, Leder+Weefsel Beschermslang, G-Cu-W, SR-17	83F1017012G1/4#
	Pakket/16 m, Leder+Weefsel Beschermslang, G-Cu-W, SR-17	83F1017016G1/4#
	Pakket/ 4 m, Leder+Weefsel Beschermslang, G-Cu-W, SR-24 G	83F1024G04G1/4#
	Pakket/ 8 m, Leder+Weefsel Beschermslang, G-Cu-W, SR-24 G	83F1024G08G1/4#
	Pakket/12 m, Leder+Weefsel Beschermslang, G-Cu-W, SR-24 G	83F1024G12G1/4#
	Pakket/16 m, Leder+Weefsel Beschermslang, G-Cu-W, SR-24 G	83F1024G16G1/4#
	Pakket/ 4 m, Leder+Weefsel Beschermslang, G-Cu-W, SR-26	83F1026004G1/4#
	Pakket/ 8 m, Leder+Weefsel Beschermslang, G-Cu-W, SR-26	83F1026008G1/4#
	Pakket/12 m, Leder+Weefsel Beschermslang, G-Cu-W, SR-26	83F1026012G1/4#
	Pakket/16 m, Leder+Weefsel Beschermslang, G-Cu-W, SR-26	83F1026016G1/4#
	Pakket/ 4 m, Leder+Weefsel Beschermslang, G-Cu-W, SR-20/24 W	83F1020004M12X1#
	Pakket/ 8 m, Leder+Weefsel Beschermslang, G-Cu-W, SR-20/24 W	83F1020008M12X1#
	Pakket/12 m, Leder+Weefsel Beschermslang, G-Cu-W, SR-20/24 W	83F1020012M12X1#
	Pakket/16 m, Leder+Weefsel Beschermslang, G-Cu-W, SR-20/24 W	83F1020016M12X1#
	Pakket/ 4 m, Leder+Weefsel Beschermslang, G-Cu-W, SR-20 H	83F1020H04M12X1#
	Pakket/ 8 m, Leder+Weefsel Beschermslang, G-Cu-W, SR-20 H	83F1020H08M12X1#
	Pakket/12 m, Leder+Weefsel Beschermslang, G-Cu-W, SR-20 H	83F1020H12M12X1#
	Pakket/16 m, Leder+Weefsel Beschermslang, G-Cu-W, SR-20 H	83F1020H16M12X1#
	Pakket/ 4 m, Leder+Weefsel Beschermslang, G-Cu-W, SR-18	83F1018004M12X1#
	Pakket/ 8 m, Leder+Weefsel Beschermslang, G-Cu-W, SR-18	83F1018008M12X1#
	Pakket/12 m, Leder+Weefsel Beschermslang, G-Cu-W, SR-18	83F1018012M12X1#
	Pakket/16 m, Leder+Weefsel Beschermslang, G-Cu-W, SR-18	83F1018016M12X1#
	Pakket/ 4 m, Leder+Weefsel Beschermslang, G-Cu-W, SR-18 SC	83F1018C04M12X1#
	Pakket/ 8 m, Leder+Weefsel Beschermslang, G-Cu-W, SR-18 SC	83F1018C08M12X1#
	Pakket/12 m, Leder+Weefsel Beschermslang, G-Cu-W, SR-18 SC	83F1018C12M12X1#
	Pakket/16 m, Leder+Weefsel Beschermslang, G-Cu-W, SR-18 SC	83F1018C16M12X1#

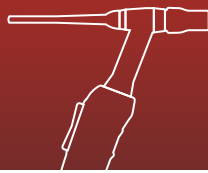

**Notities**

A large rectangular area consisting of numerous horizontal grey lines, serving as a template for handwritten notes.

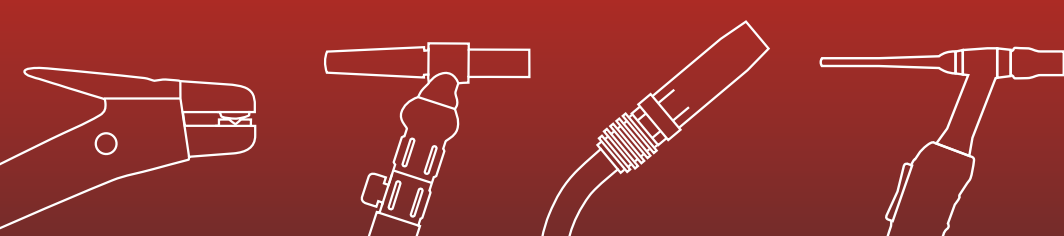

Voor verdere informatie kunt U zich aan Uw handelaar wenden.

