

# CATALOGUS 8.0

## Fittingen Fittings

### 8.1.0

#### Stroomaansluitingen

Power connector

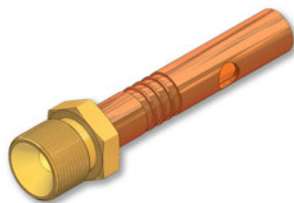

### 8.2.0

#### G/L-Aansluitingen Aansluitblok gas/water Laskabel aansluitingen

2pc power connector  
2pc adaption block  
Cable connector

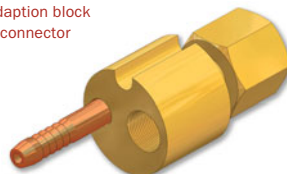

### 8.3.0

#### Stroomaansluitingen voor wartel en draaibaar draadstuk

Power connector w/o nut

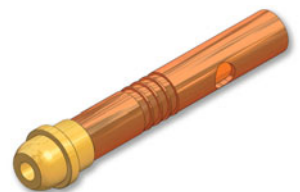

### 8.4.0

#### Wartel Kontermoer Draaibaar draadstuk

Female nut  
Counter nut  
Male swivel nut

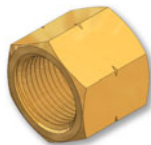

### 8.5.0

#### Dubbel nippel Draad nippel Draadmof

Double threaded adapter,  
Threaded nipple,  
Threaded coupler



### 8.6.0

#### Reduceer stukken

Reducing adapter male/female



### 8.7.0

#### Steeknippel

Quickconnect nipple  
Quickconnect coupler

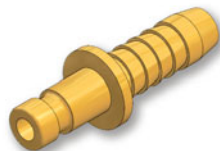

### 8.8.0

#### Slangaansluiting

Hose nipple



### 8.9.0

#### Slangverbinder

Hose connector



### 8.10.0

#### Krimphuls Een oor slangklem

Ferrule  
1-ear-clamp  
Hoseclamp



01/2014

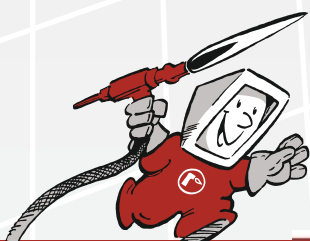

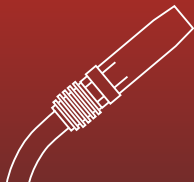
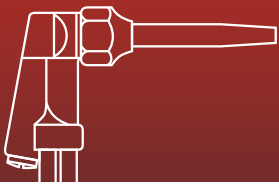

# 8.1.0

## Stroomaansluitingen

Power connector

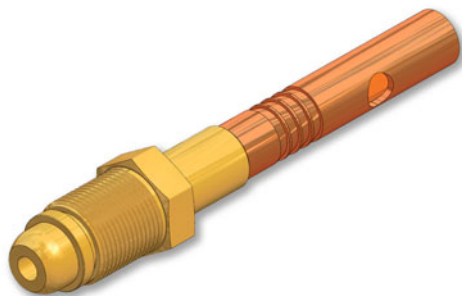
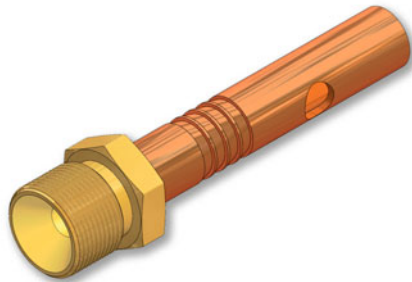
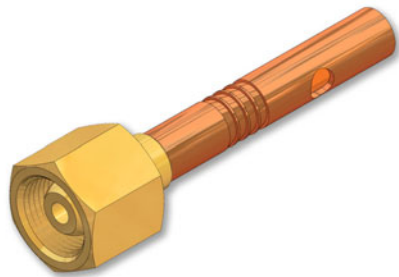

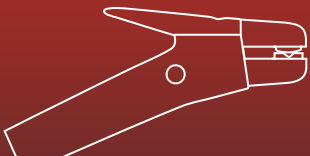

# 8.1.1

## Stroomaansluiting met wartel

Power connector with  
femal swivel nut RH

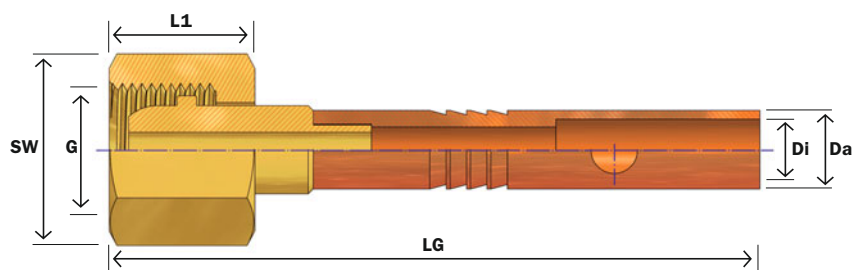

**G:** Schroefdraad, **SW:** Sleutelbreedte, **L1:** Wartel lengte, **Da:** Buitendiameter, **Di:** Binnendiameter, **LG:** Totale lengte

Artikelbeschrijving	G	SW	L1	Da	Di	LG	Bestelnummer
Stroomaansluiting M6x0,5wartel – 7 mm	M6x0,5	8	9 mm	7 mm	5 mm	60 mm	85505520107R
Stroomaansluiting M6x0,5wartel – 8 mm	M6x0,5	8	9 mm	8 mm	6 mm	60 mm	85505520108R
Stroomaansluiting M8x1wartel – 6 mm	M8x1	10	10 mm	6 mm	4 mm	69 mm	85505521106R
Stroomaansluiting M8x1wartel – 7 mm	M8x1	10	10 mm	7 mm	5,5 mm	65 mm	85505521107R
Stroomaansluiting M8x1wartel – 8 mm	M8x1	10	10 mm	8 mm	6 mm	64 mm	85505521108R
Stroomaansluiting M8x1wartel – 9 mm	M8x1	9	10 mm	9 mm	7 mm	72 mm	85505521109R
Stroomaansluiting M8x1wartel – 10 mm	M8x1	10	10 mm	10 mm	8 mm	72 mm	85505521110R
Stroomaansluiting M10x1wartel – 6 mm	M10x1	12	12 mm	6 mm	4 mm	65 mm	85505522106R
Stroomaansluiting M10x1wartel – 7 mm	M10x1	12	12 mm	7 mm	5 mm	65 mm	85505522107R
Stroomaansluiting M10x1wartel – 8 mm	M10x1	12	12 mm	8 mm	6 mm	65 mm	85505522108R
Stroomaansluiting M10x1wartel – 9 mm	M10x1	12	12 mm	9 mm	7 mm	67 mm	85505522109R
Stroomaansluiting M10x1wartel – 10 mm	M10x1	12	12 mm	10 mm	8,5 mm	69 mm	85505522110R
Stroomaansluiting M12x1wartel – 6 mm	M12x1	14	14 mm	6 mm	4 mm	72 mm	85505524106R
Stroomaansluiting M12x1wartel – 7 mm	M12x1	14	14 mm	7 mm	5 mm	72 mm	85505524107R
Stroomaansluiting M12x1wartel – 8 mm	M12x1	14	14 mm	8 mm	6 mm	72 mm	85505524108R
Stroomaansluiting M12x1wartel – 9 mm	M12x1	14	14 mm	9 mm	7 mm	72 mm	85505524109R
Stroomaansluiting M12x1wartel – 10 mm	M12x1	14	14 mm	10 mm	8 mm	72 mm	85505524110R
Stroomaansluiting M12x1wartel – 12 mm	M12x1	14	14 mm	12 mm	10 mm	72 mm	85505524112R
Stroomaansluiting M8x1wartel L=12 7 mm	M8x1	10	12 mm	7 mm	5 mm	66 mm	85505521107R-L
Stroomaansluiting M8x1wartel L=12 8 mm	M8x1	10	12 mm	8 mm	6 mm	66 mm	85505521108R-L
Stroomaansluiting M10x1wartel L=16 8 mm	M10x1	12	16 mm	8 mm	6 mm	73 mm	85505522108R-L
Stroomaansluiting M10x1wartel L=16 9 mm	M10x1	12	16 mm	9 mm	7 mm	71 mm	85505522109R-L
Stroomaansluiting M10x1wartel L=16 10 mm	M10x1	12	16 mm	10 mm	8 mm	71 mm	85505522110R-L
Stroomaansluiting G1/8"wartel – 6 mm	G1/8"	12	11 mm	6 mm	4 mm	65 mm	85505511106R
Stroomaansluiting G1/8"wartel – 7 mm	G1/8"	12	11 mm	7 mm	5 mm	65 mm	85505511107R
Stroomaansluiting G1/8"wartel – 8 mm	G1/8"	12	11 mm	8 mm	6 mm	65 mm	85505511108R
Stroomaansluiting G1/8"wartel – 9 mm	G1/8"	12	11 mm	9 mm	7 mm	67 mm	85505511109R
Stroomaansluiting G1/8"wartel – 10 mm	G1/8"	12	11 mm	10 mm	8 mm	67 mm	85505511110R
Stroomaansluiting G1/4"wartel – 6 mm	G1/4"	17	15 mm	6 mm	4 mm	72 mm	85505512106R
Stroomaansluiting G1/4"wartel – 7 mm	G1/4"	17	15 mm	7 mm	5 mm	59 mm	85505512107R
Stroomaansluiting G1/4"wartel – 8 mm	G1/4"	17	15 mm	8 mm	6 mm	63 mm	85505512108R
Stroomaansluiting G1/4"wartel – 9 mm	G1/4"	17	15 mm	9 mm	7 mm	66 mm	85505512109R
Stroomaansluiting G1/4"wartel – 10 mm	G1/4"	17	15 mm	10 mm	8 mm	7 mm	85505512110R
Stroomaansluiting G1/4"wartel – 12 mm	G1/4"	17	15 mm	12 mm	10 mm	72 mm	85505512112R

# 8.1.1

## Stroomaansluiting met wartel

Power connector with femal swivel nut RH

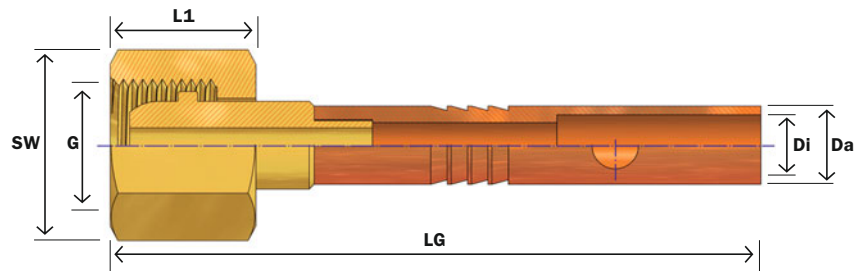

G: Schroefdraad, SW: Sleutelbreedte, L1: Wartel lengte, Da: Buitendiameter, Di: Binnendiameter, LG: Totale lengte

Artikelbeschrijving	G	SW	L1	Da	Di	LG	Bestelnummer
Stroomaansluiting G3/8"wartel – 6 mm	G3/8"	19	17 mm	6 mm	4 mm	56 mm	85505513106R
Stroomaansluiting G3/8"wartel – 7 mm	G3/8"	19	17 mm	7 mm	5 mm	66 mm	85505513107R
Stroomaansluiting G3/8"wartel – 8 mm	G3/8"	19	17 mm	8 mm	6 mm	66 mm	85505513108R
Stroomaansluiting G3/8"wartel – 9 mm	G3/8"	19	17 mm	9 mm	7 mm	65 mm	85505513109R
Stroomaansluiting G3/8"wartel – 10 mm	G3/8"	19	17 mm	10 mm	8 mm	66 mm	85505513110R
Stroomaansluiting G3/8"wartel – 12 mm	G3/8"	19	17 mm	12 mm	10 mm	66 mm	85505513112R
Stroomaansluiting 1/4UNFwartel – 6 mm	1/4UNF	6	14 mm	6 mm	4 mm	66 mm	85505531106R
Stroomaansluiting 1/4UNFwartel – 7 mm	1/4UNF	6	14 mm	7 mm	5,5 mm	66 mm	85505531107R
Stroomaansluiting 1/4UNFwartel – 8 mm	1/4UNF	6	14 mm	8 mm	6 mm	69 mm	85505531108R
Stroomaansluiting 1/4UNFwartel – 9 mm	1/4UNF	6	14 mm	9 mm	7 mm	69 mm	85505531109R
Stroomaansluiting 3/8UNFwartel – 7 mm	3/8UNF	11	12 mm	7 mm	5 mm	64 mm	85505532107R
Stroomaansluiting 3/8UNFwartel – 8 mm	3/8UNF	11	12 mm	8 mm	6 mm	65 mm	85505532108R
Stroomaansluiting 3/8UNFwartel – 9 mm	3/8UNF	12	12 mm	9 mm	7 mm	73 mm	85505532109R
Stroomaansluiting 5/8UNFwartel – 7 mm	5/8UNF	19	16 mm	7 mm	5 mm	68 mm	85505536107R
Stroomaansluiting 5/8UNFwartel – 8 mm	5/8UNF	19	16 mm	8 mm	6 mm	68 mm	85505536108R
Stroomaansluiting 5/8UNFwartel – 9 mm	5/8UNF	19	16 mm	9 mm	7 mm	68 mm	85505536109R
Stroomaansluiting 5/8UNFwartel – 10 mm	5/8UNF	19	16 mm	10 mm	8 mm	68 mm	85505536110R
Stroomaansluiting 7/16UNFwartel – 6 mm	7/16UNF	28	26 mm	6 mm	4 mm	67 mm	85505538106R
Stroomaansluiting 7/16UNFwartel – 7 mm	7/16UNF	28	26 mm	7 mm	6 mm	67 mm	85505538107R
Stroomaansluiting 7/16UNFwartel – 8 mm	7/16UNF	28	26 mm	8 mm	6 mm	67 mm	85505538108R
Stroomaansluiting 7/16UNFwartel – 9 mm	7/16UNF	14	12 mm	9 mm	7 mm	67 mm	85505538109R
Stroomaansluiting 7/16UNFwartel – 10 mm	7/16UNF	28	26 mm	10 mm	8 mm	67 mm	85505538110R
Stroomaansluiting 9/16UNFwartel – 6 mm	9/16UNF	17	16 mm	6 mm	4 mm	67 mm	85505535106R
Stroomaansluiting 9/16UNFwartel – 7 mm	9/16UNF	17	16 mm	7 mm	5 mm	67 mm	85505535107R
Stroomaansluiting 9/16UNFwartel – 8 mm	9/16UNF	17	16 mm	8 mm	6 mm	67 mm	85505535108R
Stroomaansluiting 9/16UNFwartel – 9 mm	9/16UNF	17	16 mm	9 mm	7 mm	67 mm	85505535109R
Stroomaansluiting 9/16UNFwartel – 10 mm	9/16UNF	17	16 mm	10 mm	8 mm	67 mm	85505535110R

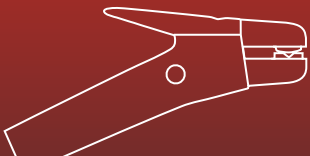

# 8.1.2

## Stroomaansluiting met vaste draad

Power connector with fixed thread RH

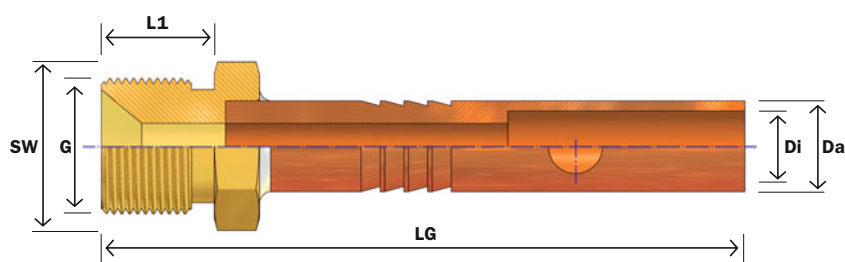

G: Schroefdraad, SW: Sleutelbreedte, L1: Lengte schroefdraad, Da: Buitendiameter, Di: Binnendiameter, LG: Totale lengte

Artikelbeschrijving	G	SW	L1	Da	Di	LG	Bestelnummer
Stroomaansluiting M8x1schroefdraad – 8 mm	M8x1	11	8 mm	8 mm	6 mm	60 mm	85505521308R
Stroomaansluiting M8x1schroefdraad – 9 mm	M8x1	11	8 mm	9 mm	7 mm	60 mm	85505521309R
Stroomaansluiting M10x1schroefdraad – 6 mm	M10x1	10	12 mm	6 mm	4 mm	61 mm	85505522306R
Stroomaansluiting M10x1schroefdraad – 7 mm	M10x1	10	12 mm	7 mm	5 mm	61 mm	85505522307R
Stroomaansluiting M10x1schroefdraad – 8 mm	M10x1	10	12 mm	8 mm	6 mm	61 mm	85505522308R
Stroomaansluiting M10x1schroefdraad – 9 mm	M10x1	12	12 mm	9 mm	7 mm	66 mm	85505522309R
Stroomaansluiting M10x1schroefdraad – 10 mm	M10x1	12	12 mm	10 mm	8 mm	66 mm	85505522310R
Stroomaansluiting M10x1,5schroefdraad – 8 mm	M10x1,5	11	9 mm	8 mm	6 mm	59 mm	85505552308R
Stroomaansluiting M12x1schroefdraad – 6 mm	M12x1	12	11 mm	6 mm	4 mm	58 mm	85505524306R
Stroomaansluiting M12x1schroefdraad – 7 mm	M12x1	12	11 mm	7 mm	5 mm	58 mm	85505524307R
Stroomaansluiting M12x1schroefdraad – 8 mm	M12x1	12	11 mm	8 mm	6 mm	58 mm	85505524308R
Stroomaansluiting M12x1schroefdraad – 9 mm	M12x1	12	11 mm	9 mm	7 mm	58 mm	85505524309R
Stroomaansluiting M12x1schroefdraad – 10 mm	M12x1	12	11 mm	10 mm	8 mm	58 mm	85505524310R
Stroomaansluiting M12x1,5schroefdraad – 8 mm	M12x1,5	12	8 mm	8 mm	6 mm	57 mm	85505526308R
Stroomaansluiting M12x1,5schroefdraad – 9 mm	M12x1,5	14	8 mm	9 mm	7 mm	57 mm	85505526309R
Stroomaansluiting M12x1,75schroefdraad – 8 mm	M12x1,75	14	11 mm	8 mm	6 mm	62 mm	85505527308R
Stroomaansluiting M12x1,75schroefdraad – 9 mm	M12x1,75	14	11 mm	9 mm	7 mm	62 mm	85505527309R
Stroomaansluiting G1/4"schroefdraad – 6 mm	G1/4"	14	12 mm	6 mm	4 mm	61 mm	85505512306R
Stroomaansluiting G1/4"schroefdraad – 7 mm	G1/4"	14	12 mm	7 mm	5 mm	61 mm	85505512307R
Stroomaansluiting G1/4"schroefdraad – 8 mm	G1/4"	14	12 mm	8 mm	6 mm	61 mm	85505512308R
Stroomaansluiting G1/4"schroefdraad – 9 mm	G1/4"	14	12 mm	9 mm	7 mm	62 mm	85505512309R
Stroomaansluiting G1/4"schroefdraad – 10 mm	G1/4"	14	12 mm	10 mm	8 mm	62 mm	85505512310R

# 8.1.3

## Stroomaansluiting met draaibaar draadstuk

Power connector with male swivel nut RH and LH

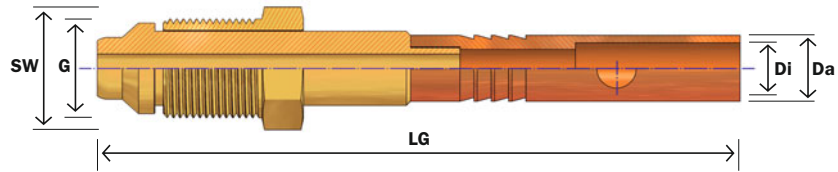

G: Schroefdraad, SW: Sleutelbreedte, Da: Buitendiameter, Di: Binnendiameter, LG: Totale lengte

Artikelbeschrijving	G	SW	Da	Di	LG	Bestelnummer
Stroomaansluiting M8x1schroefdraad – 6 mm	M8x1	9	6 mm	4 mm	64 mm	85505521206R
Stroomaansluiting M8x1schroefdraad – 7 mm	M8x1	9	7 mm	5 mm	68 mm	85505521207R
Stroomaansluiting M8x1schroefdraad – 8 mm	M8x1	9	8 mm	6 mm	67 mm	85505521208R
Stroomaansluiting M8x1schroefdraad – 9 mm	M8x1	9	9 mm	7 mm	71 mm	85505521209R
Stroomaansluiting M10x1schroefdraad – 8 mm	M10x1	11	8 mm	6 mm	68 mm	85505522208R
Stroomaansluiting M10x1schroefdraad – 9 mm	M10x1	10	9 mm	7 mm	74 mm	85505522209R
Stroomaansluiting G1/8"schroefdraad – 8 mm	G1/8"	11	8 mm	6 mm	71 mm	85505511208R
Stroomaansluiting G1/8"schroefdraad – 9 mm	G1/8"	11	9 mm	7 mm	71 mm	85505511209R
Stroomaansluiting 1/4UNFschroefdraad – 6 mm	1/4UNF	7	6 mm	4 mm	60 mm	85505531206R
Stroomaansluiting 1/4UNFschroefdraad – 7 mm	1/4UNF	7	7 mm	5 mm	61 mm	85505531207R
Stroomaansluiting 1/4UNFschroefdraad – 8 mm	1/4UNF	8	8 mm	6 mm	67 mm	85505531208R
Stroomaansluiting 1/4UNFschroefdraad – 9 mm	1/4UNF	8	9 mm	7 mm	67 mm	85505531209R
Stroomaansluiting 3/8UNFschroefdraad – 7 mm	3/8UNF	10	7 mm	5 mm	65 mm	85505532207R
Stroomaansluiting 3/8UNFschroefdraad – 8 mm	3/8UNF	10	8 mm	6 mm	68 mm	85505532208R
Stroomaansluiting 3/8UNFschroefdraad – 9 mm	3/8UNF	10	9 mm	7 mm	71 mm	85505532209R
Stroomaansluiting 3/8UNFschroefdraad – 10 mm	3/8UNF	10	10 mm	8 mm	74 mm	85505532210R
Stroomaansluiting 3/8UNFschroefdraad – 7 mm	3/8UNF links	10	7 mm	5 mm	65 mm	85505532207L
Stroomaansluiting 3/8UNFschroefdraad – 8 mm	3/8UNF links	10	8 mm	6 mm	68 mm	85505532208L
Stroomaansluiting 3/8UNFschroefdraad – 9 mm	3/8UNF links	10	9 mm	7 mm	68 mm	85505532209L
Stroomaansluiting 3/8UNFschroefdraad – 10 mm	3/8UNF links	10	10 mm	8 mm	68 mm	85505532210L
Stroomaansluiting 5/8UNFschroefdraad – 6 mm	5/8UNF	12	6 mm	4 mm	82 mm	85505536206R
Stroomaansluiting 5/8UNFschroefdraad – 7 mm	5/8UNF	12	7 mm	5 mm	82 mm	85505536207R
Stroomaansluiting 5/8 UNFschroefdraad – 8 mm	5/8UNF	12	8 mm	6 mm	82 mm	85505536208R
Stroomaansluiting 5/8 UNFschroefdraad – 9 mm	5/8UNF	12	9 mm	7 mm	82 mm	85505536209R
Stroomaansluiting 5/8 UNFschroefdraad – 10 mm	5/8UNF	12	10 mm	8 mm	82 mm	85505536210R
Stroomaansluiting 5/8UNFschroefdraad – 6 mm	5/8UNF links	12	6 mm	4 mm	72 mm	85505536206L
Stroomaansluiting 5/8UNFschroefdraad – 7 mm	5/8UNF links	12	7 mm	5 mm	72 mm	85505536207L
Stroomaansluiting 5/8UNFschroefdraad – 8 mm	5/8UNF links	12	8 mm	6 mm	82 mm	85505536208L
Stroomaansluiting 5/8UNFschroefdraad – 9 mm	5/8UNF links	12	9 mm	7 mm	82 mm	85505536209L
Stroomaansluiting 5/8UNFschroefdraad – 10 mm	5/8UNF links	12	10 mm	8 mm	82 mm	85505536210L
Stroomaansluiting 5/8UNFschroefdraad – 12 mm	5/8UNF	17	12 mm	9 mm	100 mm	85505536212R
Stroomaansluiting 7/8UNFschroefdraad – 7 mm	7/8UNF	24	7 mm	5 mm	78 mm	85505537207R
Stroomaansluiting 7/8UNFschroefdraad – 8 mm	7/8UNF	24	8 mm	6 mm	78 mm	85505537208R
Stroomaansluiting 7/8UNFschroefdraad – 9 mm	7/8UNF	24	9 mm	7 mm	78 mm	85505537209R
Stroomaansluiting 7/8UNFschroefdraad – 10 mm	7/8UNF	24	10 mm	8 mm	78 mm	85505537210R.
Stroomaansluiting 7/8UNFschroefdraad – 12 mm	7/8UNF	24	12 mm	10 mm	78 mm	85505537212R
Stroomaansluiting 7/8UNFschroefdraad – 7 mm	7/8UNF links	24	7 mm	5 mm	78 mm	85505537207L
Stroomaansluiting 7/8UNFschroefdraad – 8 mm	7/8UNF links	24	8 mm	6 mm	78 mm	85505537208L
Stroomaansluiting 7/8UNFschroefdraad – 9 mm	7/8UNF links	24	9 mm	7 mm	78 mm	85505537209L
Stroomaansluiting 7/8UNFschroefdraad – 10 mm	7/8UNF links	24	10 mm	8 mm	78 mm	85505537210L
Stroomaansluiting 7/8UNFschroefdraad – 12 mm	7/8UNF links	24	12 mm	10 mm	78 mm	85505537212L

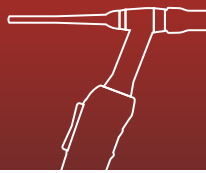

# 8.2.0

**Stroom gasaansluitingen**  
**Aansluitblok gas/water**  
**Laskabel aansluitingen**

2pc power connector  
2pc adaption block  
Cable connector

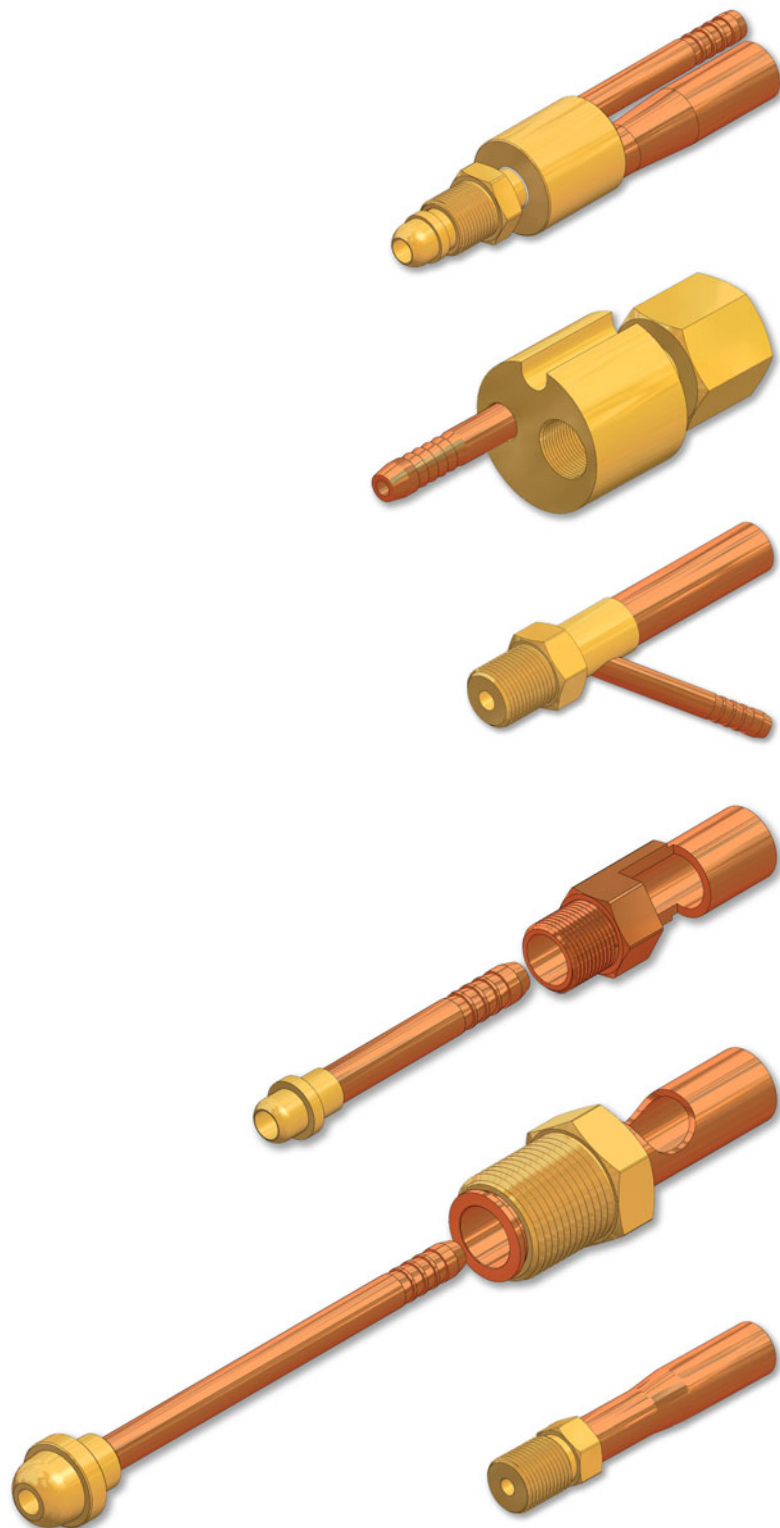

## 8.2.1

### Stroom gasaansluiting met wartel en rechte gasaansluiting

2pc power connector,  
female swivel nut RH,  
straight gas nipple

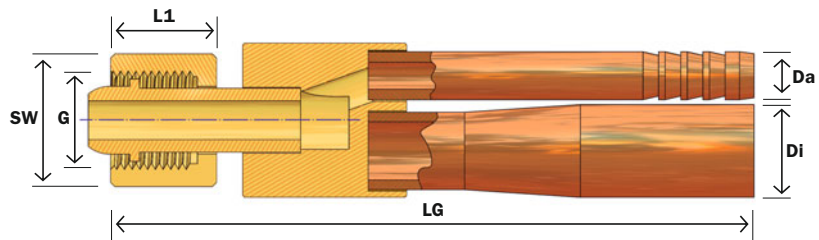

G: Schroefdraad, SW: Sleutelbreedte, L1: Wartel lengte, Da: Diameter gasaansluiting, Di: Laskabel doorsnede, LG: Totale lengte

Artikelbeschrijving	G	SW	L1	Di	Da	LG	Bestelnummer
Stroom gasaansluiting, G1/8"wartel 16–25 mm <sup>2</sup> , rechte gasaansluiting	G1/8"	12	11 mm	16–25 mm <sup>2</sup>	5 mm	72,5 mm	8550562-111R-1
Stroom gasaansluiting, G1/4"wartel 16–35 mm <sup>2</sup> , rechte gasaansluiting	G1/4"	17	15,5 mm	16–35 mm <sup>2</sup>	5 mm	78 mm	8550562-112R-3

## 8.2.2

### Stroom gasaansluiting met draaibaar draadstuk en rechte gasaansluiting

2pc power connector,  
male swivel nut RH,  
straight gas nipple

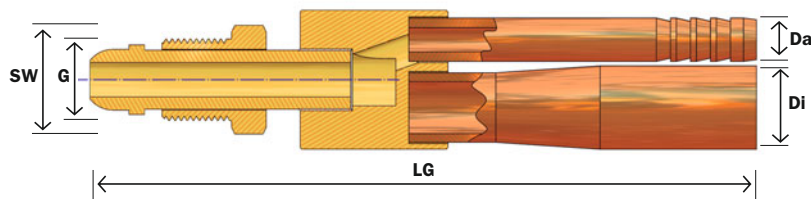

G: Schroefdraad, SW: Sleutelbreedte, Da: Diameter gasaansluiting, Di: Laskabel doorsnede, LG: Totale lengte

Artikelbeschrijving	G	SW	Di	Da	LG	Bestelnummer
Stroom gasaansl. 3/8UNFr.sd 16–25mm <sup>2</sup> , rechte gasaansluiting	3/8UNF	11	16–25 mm <sup>2</sup>	5 mm	76 mm	8550562-232R-1

## 8.2.3

### Stroom gasaansluiting met wartel en zijdelingse gasaansluiting

2pc power connector,  
female swivel nut RH,  
side nipple

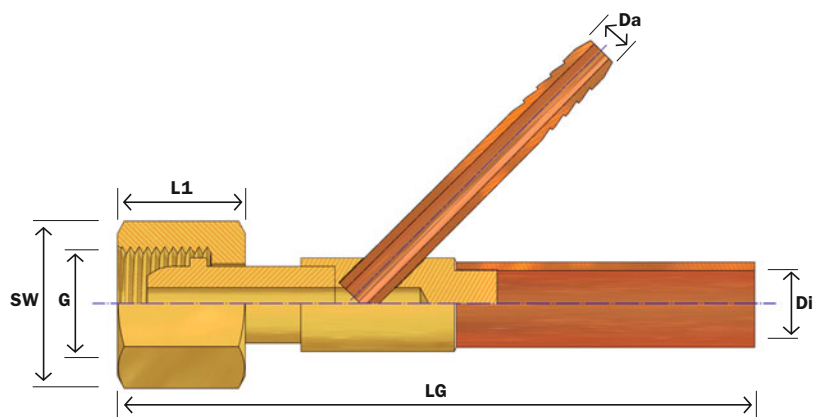

G: Schroefdraad, SW: Sleutelbreedte, L1: Wartel lengte, Da: Diameter gasaansluiting, Di: Laskabel doorsnede, LG: Totale lengte

Artikelbeschrijving	G	SW	L1	Di	Da	LG	Bestelnummer
Stroom gasaansl. M12x1wartel 16–25 mm <sup>2</sup> , zijdelingse gasaansluiting	M12x1	14	14 mm	16–25 mm <sup>2</sup>	5 mm	76 mm	8550561-124R-1



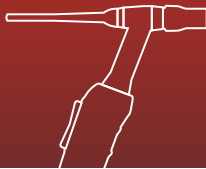
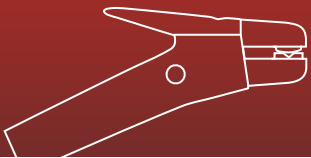

## 8.2.4

### Stroom gasaansluiting met draaibaar draadstuk en zijdelingse gasaansluiting

2pc power connector,  
male swivel nut RH,  
side nipple

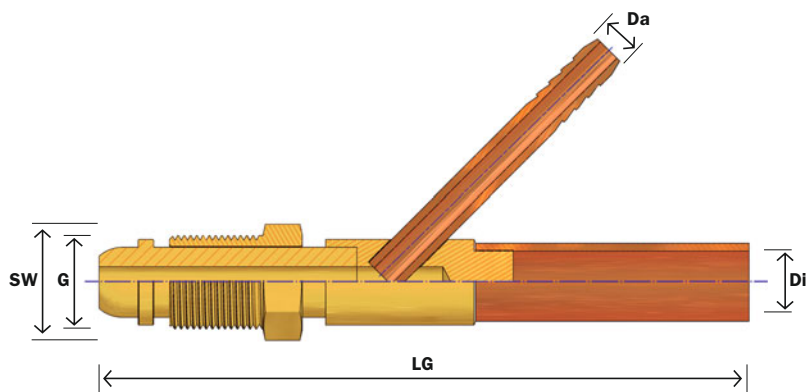

**G:** Schroefdraad, **SW:** Sleutelbreedte, **Da:** Diameter gasaansluiting, **Di:** Laskabel doorsnede, **LG:** Totale lengte

Artikelbeschrijving	G	SW	Di	Da	LG	Bestelnummer
Stroom gasaansl. M10x1schroefdraad 16–25 mm <sup>2</sup> zijdelingse gasaansluiting	M10x1	11	16–25 mm <sup>2</sup>	6 mm	59 mm	8550561-222R-1
Stroom gasaansl. 5/8UNFschroefdraad 25–50 mm <sup>2</sup> zijdelingse gasaansluiting	5/8UNF	17	25–50 mm <sup>2</sup>	6 mm	88,5 mm	8550561-236R-1

## 8.2.5

### Stroom gasaansluiting met vaste draad en zijdelingse gasaansluiting

2pc power connector,  
fixed thread RH,  
side nipple

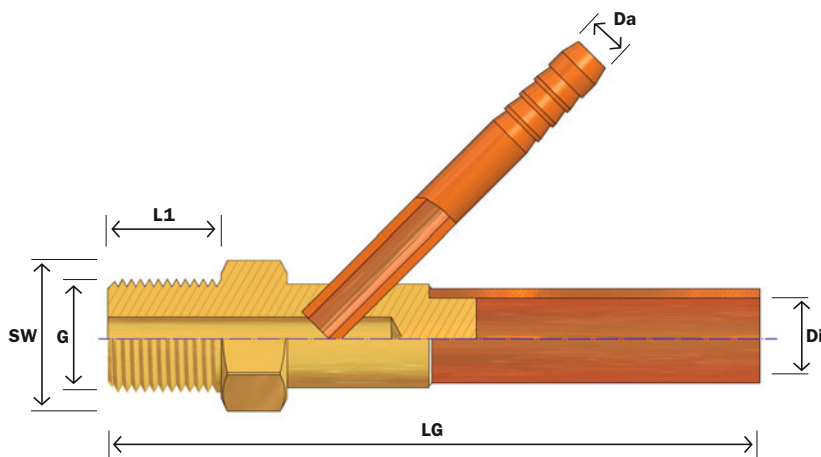

**G:** Schroefdraad, **SW:** Sleutelbreedte, **L1:** Lengte schroefdraad, **Da:** Diameter gasaansluiting, **Di:** Laskabel doorsnede, **LG:** Totale lengte

Artikelbeschrijving	G	SW	L1	Di	Da	LG	Bestelnummer
Stroom gasaansl. M12x1schroefdr. 16–25mm <sup>2</sup> , zijdelingse gasaansluiting	M12x1	14	12 mm	16–25 mm <sup>2</sup>	5 mm	69 mm	8550561-324R-1
Stroom gasaansl. M12x1schroefdr. 35–50mm <sup>2</sup> , zijdelingse gasaansluiting	M12x1	14	12 mm	35–50 mm <sup>2</sup>	5 mm	74 mm	8550561-324R-3
Stroom gasaansl. G1/4"schroefdr. 16–25 mm <sup>2</sup> zijdelingse gasaansluiting	G1/4"	14	12 mm	16–25 mm <sup>2</sup>	5 mm	70 mm	8550561-312R-1
Stroom gasaansl. G1/4"schroefdr. 35–50mm <sup>2</sup> , zijdelingse gasaansluiting	G1/4"	14	12 mm	35–50 mm <sup>2</sup>	5 mm	70 mm	8550561-312R-3

## 8.2.6

### Aansluitblok gas/water 24 mm stroomkabel met wartel

2pc adaption block with  
female swivel nut RH

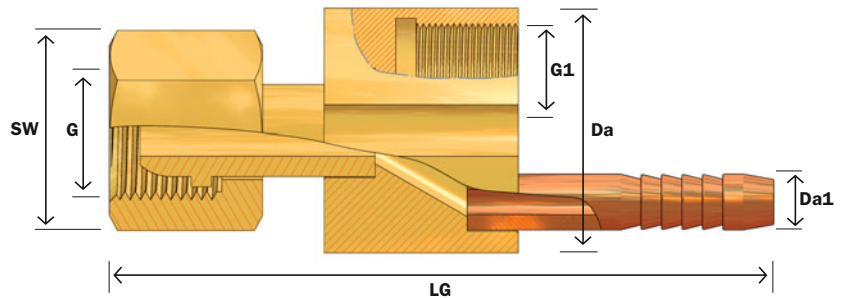

G: Schroefdraad, SW: Sleutelbreedte, G1: Aansluiting schroefdraad, Da: Buitendiameter, LG: Totale lengte

Artikelbeschrijving	G	SW	Da	G1	Da1	LG	Bestelnummer
Aansluitblok gas/water 24 mm M12x1wartel M10x1binnendraad	M12x1	14	24 mm	M10x1	5,5 mm	67,5 mm	8550563-124R
Aansluitblok gas/water 24 mm G1/4"wartel M10x1binnendraad	G1/4"	17	24 mm	M10x1	5,5 mm	67,5 mm	8550563-112R
Aansluitblok gas/water 24 mm G3/8"wartel M10x1binnendraad	G3/8"	19	24 mm	M10x1	5,5 mm	67,5 mm	8550563-113R

## 8.2.7

### Aansluitblok gas/water 24 mm met vaste draad

2pc adaption block with  
fixed male thread RH

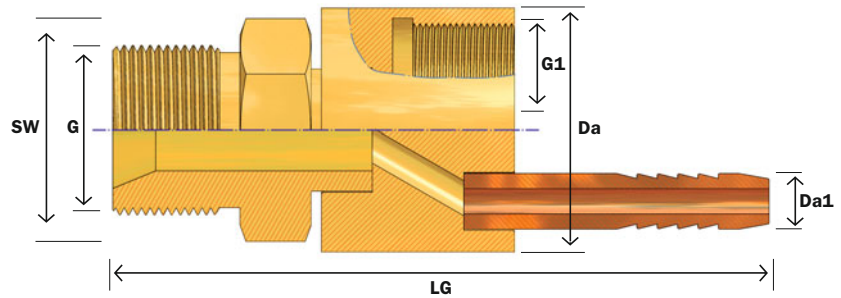

G: Schroefdraad, SW: Sleutelbreedte, G1: Aansluiting schroefdraad, Da: Buitendiameter, LG: Totale lengte

Artikelbeschrijving	G	SW	DA	G1	Da1	LG	Bestelnummer
Aansluitblok gas/water 24 mm M12x1schroefdraad M10x1binnendraad	M12x1		24 mm	M10x1	5,5 mm	67,5 mm	8550563-324R
Aansluitblok gas/water 24 mm G1/4"schroefdraad M10x1binnendraad	G1/4"		24 mm	M10x1	5,5 mm	67,5 mm	8550563-312R
Aansluitblok gas/water 24 mm G3/8"schroefdraad M10x1binnendraad	G3/8"		24 mm	M10x1	5,5 mm	67,5 mm	8550563-313R

# 8.2.8

## Laskabel aansluitingen

Cable connector

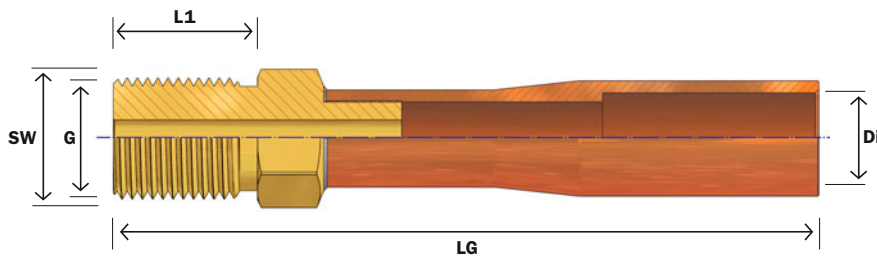

**G:** Schroefdraad, **SW:** Sleutelbreedte, **L1:** Lengte schroefdraad, **Di:** Laskabel doorsnede, **LG:** Totale lengte

### Artikelbeschrijving

Artikelbeschrijving	G	SW	L1	Di	LG	Bestelnummer
Stroomaansluiting M10x1buitendraad v. laskabel 16–25 mm <sup>2</sup>	M10x1	10	12 mm	16–25 mm <sup>2</sup>	59 mm	8550569-322R-1
Stroomaansluiting M10x1buitendraad v. laskabel 35–50 mm <sup>2</sup>	M10x1	10	12 mm	35–50 mm <sup>2</sup>	59 mm	8550569-322R-2
Stroomaansluiting M10x1buitendraad v. laskabel 70–95 mm <sup>2</sup>	M10x1	10	12 mm	70–95 mm <sup>2</sup>	69 mm	8550569-322R-7

# 8.2.9

## Stroom gasaansluiting C17 met separate slangaansluiting

2pc power connector,  
fixed thread RH,  
separate gas nipple

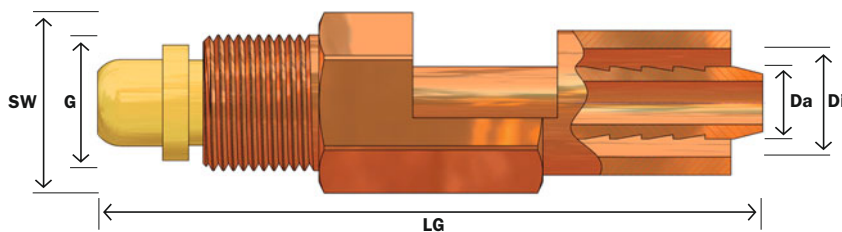

**G:** Schroefdraad, **SW:** Sleutelbreedte, **Da:** Diameter gasaansluiting, **Di:** Laskabel doorsnede, **LG:** Totale lengte

### Artikelbeschrijving

Artikelbeschrijving	G	SW	Di	Da	LG	Bestelnummer
Stroomaansluiting C17 cplt (2-delig)	3/8UNF	11	16–25 mm <sup>2</sup>	5 mm	46 mm	8550569170
Stroomaansluiting C17 (3/8UNFschroefdr.)	3/8UNF	11	16–25 mm <sup>2</sup>		36 mm	8550569171
Slangaansluiting N17L 5mm (C17)	3/8UNF		3 mm	5 mm	46 mm	8550569171L

## 8.2.10

### Stroomaansluiting C26 G/L

2pc power connector, male swivel nut RH, separate gas nipple

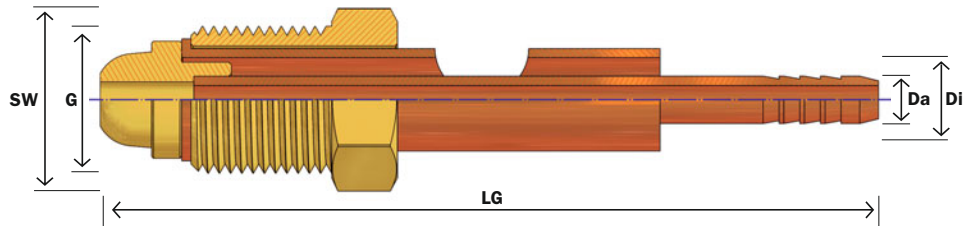

G: Schroefdraad, SW: Sleutelbreedte, Da: Diameter gasaansluiting, Di: Laskabel doorsnede, LG: Totale lengte

Artikelbeschrijving	G	SW	Di	Da	LG	Bestelnummer
Stroomaansluiting C26 G/L cpl (3-delig)	5/8UNF	17	25–35 mm <sup>2</sup>	5 mm	83 mm	8550569260
Stroomaansluiting C26			25–35 mm <sup>2</sup>		51 mm	8550569261
Draaibaar draadstuk 5/8UNF	5/8UNF	17				855053236R
Slangaansluiting N26L 5 mm (C26)	5/8UNF		3 mm	5 mm	83 mm	8550569261L

## 8.2.11

### Stroomaansluiting C17D G/L

2pc power connector, female swivel nut RH, separate gas nipple

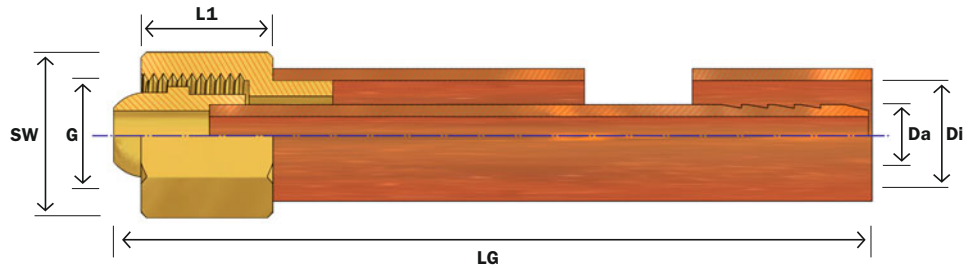

G: Schroefdraad, SW: Sleutelbreedte, L1: Wartel lengte, Da: Buitendiameter, Di: Laskabel doorsnede, LG: Totale lengte

Artikelbeschrijving	G	SW	L1	Di	Da	LG	Bestelnummer
Stroomaansluiting C17D cpl (2-delig)	G1/8	12	12 mm	16–35 mm <sup>2</sup>		72 mm	855056917D
Stroomaansluiting C17D G1/8"binnendraad	G1/8	12	12 mm	16–35 mm <sup>2</sup>		63 mm	855056917DS
Slangaansluiting N17D 5 mm (C17D)	G1/8			3 mm	5 mm	68 mm	855056917DL

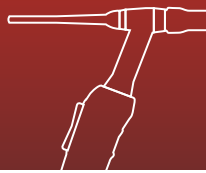

**ROHRMAN**  
SCHWEISSTECHNIK

# 8.3.0

**Stroomaansluitingen  
voor wartel  
en draaibaar draadstuk**

Power connector w/o nut

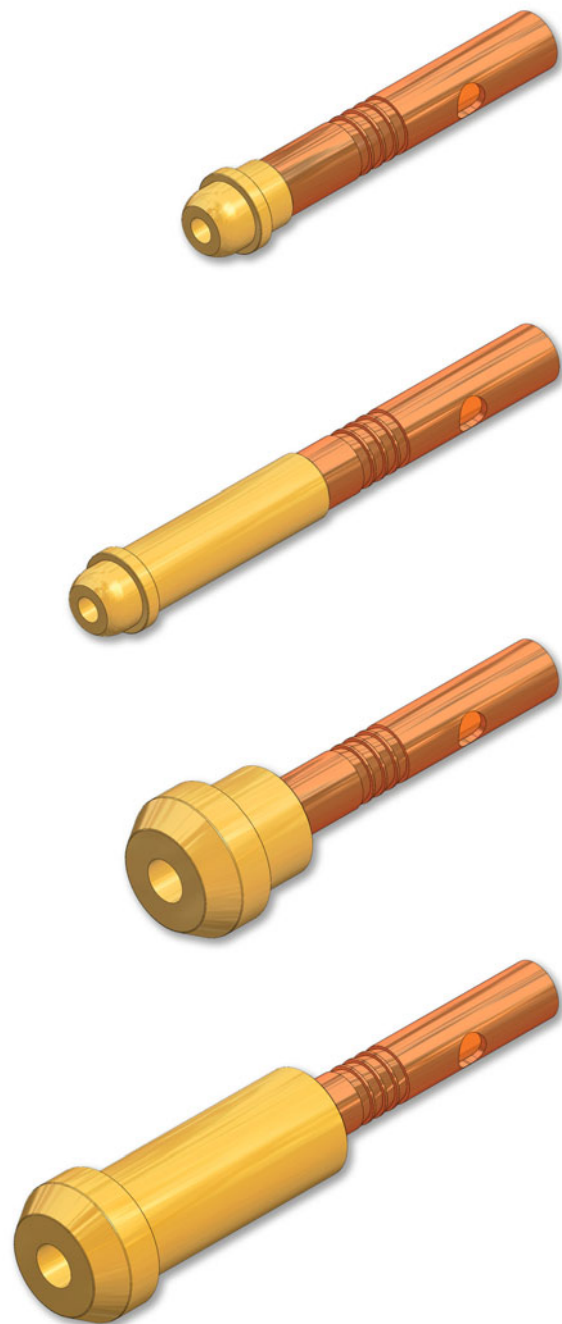

# 8.3.1

## Stroomaansluitingen voor wartel

Power connector w/o nut

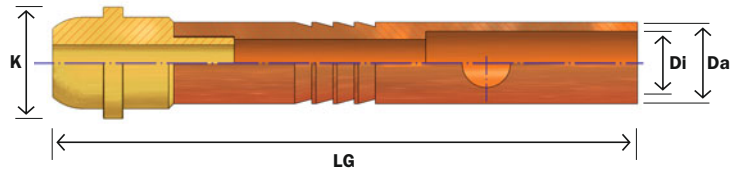

K: Konus, Da: Buitendiameter, Di: Binnendiameter, LG: Totale lengte

Artikelbeschrijving	K	Da	Di	LG	Bestelnummer
Stroomaansluiting v. M10 / G1/8" – 6 mm	M10 / G1/8"	6 mm	4 mm	58 mm	85505411106
Stroomaansluiting v. M10 / G1/8" – 7 mm	M10 / G1/8"	7 mm	5 mm	60 mm	85505411107
Stroomaansluiting v. M12 / G1/4" – 6 mm	M12 / G1/4"	6 mm	4 mm	51 mm	85505411206
Stroomaansluiting v. M12 / G1/4" – 7 mm	M12 / G1/4"	7 mm	5,5 mm	55 mm	85505411207
Stroomaansluiting v. M12 / G1/4" – 8 mm	M12 / G1/4"	8 mm	6 mm	58 mm	85505411208
Stroomaansluiting v. M12 / G1/4" – 9 mm	M12 / G1/4"	9 mm	7 mm	60 mm	85505411209
Stroomaansluiting v. G3/8" – 6 mm	G3/8"	6 mm	4,5 mm	55 mm	85505411306
Stroomaansluiting v. G3/8" – 7 mm	G3/8"	7 mm	5 mm	58 mm	85505411307
Stroomaansluiting v. G3/8" – 8 mm	G3/8"	8 mm	6 mm	60 mm	85505411308
Stroomaansluiting v. G3/8" – 9 mm	G3/8"	9 mm	7 mm	60 mm	85505411309
Stroomaansluiting v. G3/8" – 10 mm	G3/8"	10 mm	8 mm	62 mm	85505411310
Stroomaansluiting v. G3/8" – 12 mm	G3/8"	12 mm	9 mm	80 mm	85505411312
Stroomaansluiting v. G1/2" – 7 mm	G1/2"	7 mm	5 mm	56 mm	85505411407
Stroomaansluiting v. G1/2" – 8 mm	G1/2"	8 mm	6 mm	58 mm	85505411408
Stroomaansluiting v. G1/2" – 9 mm	G1/2"	9 mm	7 mm	58 mm	85505411409
Stroomaansluiting v. G1/2" – 10 mm	G1/2"	10 mm	8 mm	58 mm	85505411410
Stroomaansluiting v. 9/16UNF – 6 mm	9/16UNF	6 mm	4 mm	52 mm	85505413506
Stroomaansluiting v. 9/16UNF – 7 mm	9/16UNF	7 mm	5 mm	52 mm	85505413507
Stroomaansluiting v. 9/16UNF – 8 mm	9/16UNF	8 mm	6 mm	56 mm	85505413508
Stroomaansluiting v. 9/16UNF – 9 mm	9/16UNF	9 mm	7 mm	52 mm	85505413509
Stroomaansluiting v. 9/16UNF – 10 mm	9/16UNF	10 mm	8 mm	52 mm	85505413510

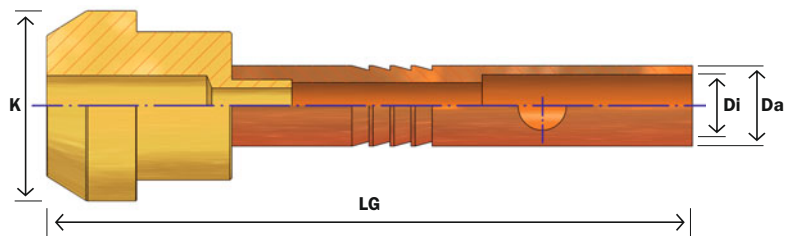

K: Konus, Da: Buitendiameter, Di: Binnendiameter, LG: Totale lengte

Artikelbeschrijving	K	Da	Di	LG	Bestelnummer
Stroomaansluiting v. 7/8UNF wartel – 6 mm	7/8UNF	6 mm	4 mm	59 mm	85505413706
Stroomaansluiting v. 7/8UNF wartel – 7 mm	7/8UNF	7 mm	5 mm	59 mm	85505413707
Stroomaansluiting v. 7/8UNF wartel – 8 mm	7/8UNF	8 mm	6 mm	59 mm	85505413708
Stroomaansluiting v. 7/8UNF wartel – 9 mm	7/8UNF	9 mm	7 mm	59 mm	85505413709
Stroomaansluiting v. 7/8UNF wartel – 10 mm	7/8UNF	10 mm	8 mm	59 mm	85505413710

# 8.3.2

## Stroomaansluitingen voor draaibaar draadstuk

Power connector w/o nut

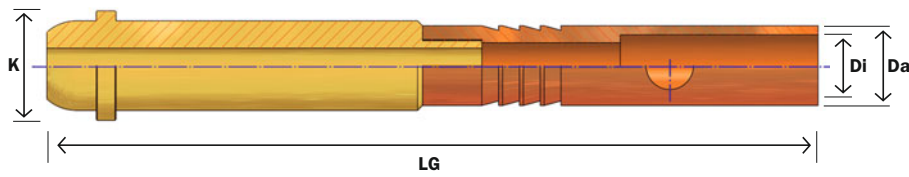

**K:** Konus, **Da:** Buitendiameter, **Di:** Binnendiameter, **LG:** Totale lengte

Artikelbeschrijving	K	Da	Di	LG	Bestelnummer
Stroomaansluiting v. 5/8UNF schroefdr.–6 mm	5/8UNF	6 mm	4 mm	74 mm	85505423606
Stroomaansluiting v. 5/8UNF schroefdr.–7 mm	5/8UNF	7 mm	5 mm	79 mm	85505423607
Stroomaansluiting v. 5/8UNF schroefdr.–8 mm	5/8UNF	8 mm	6 mm	82 mm	85505423608
Stroomaansluiting v. 5/8UNF schroefdr.–9 mm	5/8UNF	9 mm	7 mm	83 mm	85505423609
Stroomaansluiting v. 5/8UNF schroefdr.–10 mm	5/8UNF	10 mm	8 mm	82 mm	85505423610

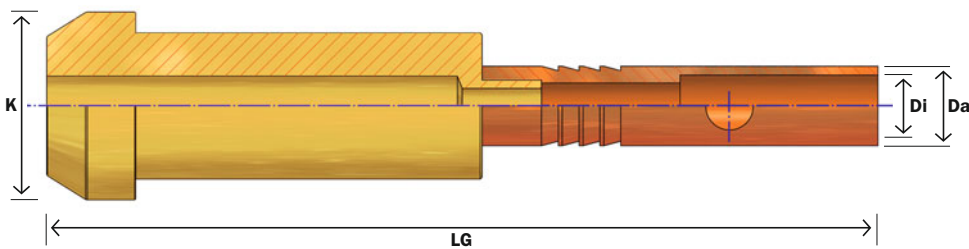

**K:** Konus, **Da:** Buitendiameter, **Di:** Binnendiameter, **LG:** Totale lengte

Artikelbeschrijving	K	Da	Di	LG	Bestelnummer
Stroomaansluiting v. 7/8UNF schroefdr.–6 mm	7/8UNF	6 mm	4 mm	77,5 mm	85505423706
Stroomaansluiting v. 7/8UNF schroefdr.–7 mm	7/8UNF	7 mm	5 mm	77,5 mm	85505423707
Stroomaansluiting v. 7/8UNF schroefdr.–8 mm	7/8UNF	8 mm	6 mm	83 mm	85505423708
Stroomaansluiting v. 7/8UNF schroefdr.–9 mm	7/8UNF	9 mm	7 mm	86 mm	85505423709
Stroomaansluiting v. 7/8UNF schroefdr.–10 mm	7/8UNF	10 mm	8 mm	86 mm	85505423710

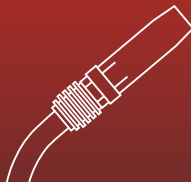
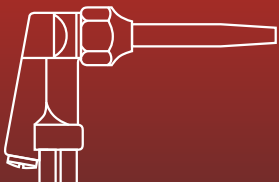

# 8.4.0

## Wartel Kontermoer Draaibaar draadstuk

- Female nut
- Counter nut
- Male swivel nut

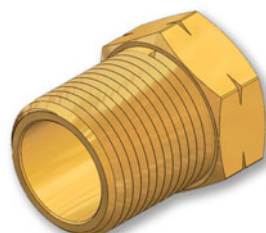
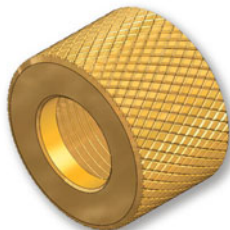
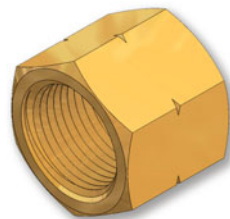
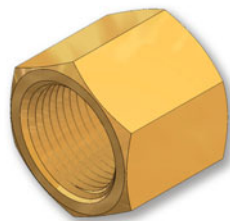



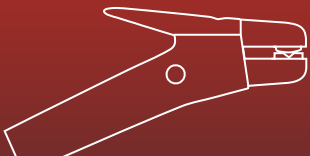

# 8.4.1

## Wartel, schroefdraad rechts- links draaiend

Female nut RH and LH

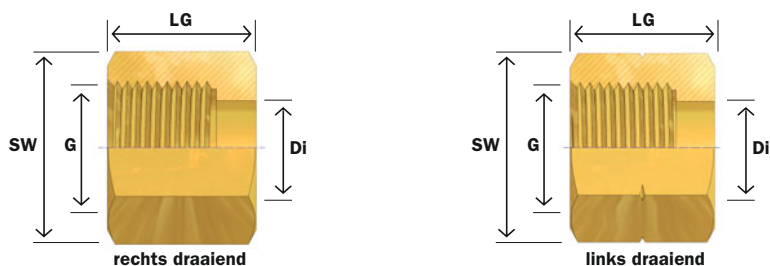

G: Schroefdraad, SW: Sleutelbreedte, Di: Binnendiameter, LG: Wartel lengte

Artikelbeschrijving	G	SW	Di	LG	Bestelnummer
Wartel M6x0,5	M6x0,5	8	4 mm	9 mm	855053120R
Wartel M8x1	M8x1	10	5 mm	10 mm	855053121R
Wartel M10x1	M10x1	12	7 mm	12 mm	855053122R
Wartel M12x1	M12x1	14	9 mm	14 mm	855053124R
Wartel M8x1/lengte 12 mm	M8x1	9	5,5 mm	12 mm	855053121R-L
Wartel M10x1/lengte 16 mm	M10x1	12	6 mm	16 mm	855053122R-L
Wartel M12x1/lengte 15,5 mm	M12x1	17	9,5 mm	15,5 mm	855053124R-L
Wartel G1/8"	G1/8"	12	7 mm	11 mm	855053111R
Wartel G1/4	G1/4"	17	9,5 mm	15 mm	855053112R
Wartel G3/8"	G3/8"	19	12,5 mm	17 mm	855053113R
Wartel G3/8" links	G3/8" links	19	12,5 mm	17 mm	855053113L
Wartel G1/2"	G1/2"	24	15 mm	22,5 mm	855053114R
Wartel 3/8UNF	3/8UNF	12	5,5 mm	11,5 mm	855053132R
Wartel 3/8UNF links	3/8UNF links	19	11 mm	16 mm	855053132L
Wartel 1/2UNF	1/2UNF				855053134R
Wartel 1/2UNF links	1/2UNF links				855053134L
Wartel 9/16UNF	9/16UNF	17	11 mm	15 mm	855053135R
Wartel 9/16UNF links	9/16UNF links	17	9,5 mm	16 mm	855053135L
Wartel 5/8UNF	5/8UNF	19	11 mm	16 mm	855053136R
Wartel 5/8UNF links	5/8UNF links	19	11 mm	16 mm	855053136L
Wartel 7/8UNF	7/8UNF	28	14,5 mm	26 mm	855053137R
Wartel 7/8UNF links	7/8UNF links	28	14,5 mm	26 mm	855053137L

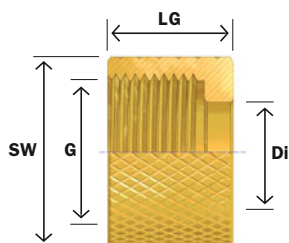

G: Schroefdraad, SW: Sleutelbreedte, Di: Binnendiameter, LG: Wartel lengte

# 8.4.2

## Wartel, schroefdraad stevig vastdraaien rechts draaiend

Female nut RH hand tightening

Artikelbeschrijving	G	SW	Di	LG	Bestelnummer
Wartel G1/4" gekarteld	G1/4"		9 mm	13,5 mm	855053112R-F
Wartel G3/8" gekarteld	G3/8"		10 mm	12,8 mm	855053113R-F

## 8.4.3

### Kontermoer, schroefdraad rechts draaiend

Lock nut RH

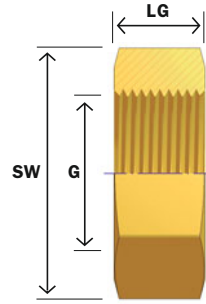

G: Schroefdraad, SW: Sleutelbreedte, LG: Hoogte

Artikelbeschrijving	G	SW	LG	Bestelnummer
Kontermoer M10x1	M10x1	14	4 mm	MKM-M10X1-M
Kontermoer M12x1	M12x1	14		855053124R
Kontermoer M12x1,25	M12x1,25			
Kontermoer G1/4"	G1/4"	17		855053312R
Kontermoer G3/8"	G3/8"	17		855053313R

## 8.4.4

### Draaibaar draadstuk, schroefdraad rechts- links draaiend

Male swivel nut RH and LH

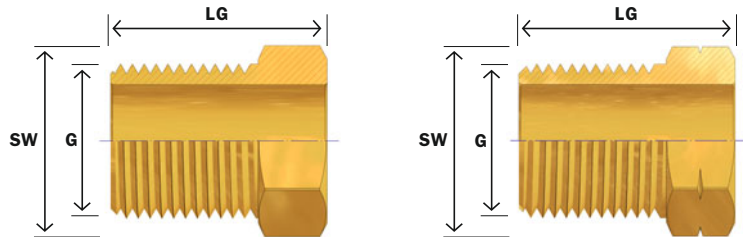

G: Schroefdraad, SW: Sleutelbreedte, LG: Lengte draaibaar draadstuk

Artikelbeschrijving	G	SW	LG	Bestelnummer
Draaibaar draadstuk M8x1	M8x1	9	13 mm	855053221R
Draaibaar draadstuk M10x1	M10x1	10	14 mm	855053222R
Draaibaar draadstuk G1/8"	G1/8"	11	13 mm	855053211R
Draaibaar draadstuk 3/8UNF	3/8UNF	10	13 mm	855053232R
Draaibaar draadstuk 5/8UNF	5/8UNF	17	22 mm	855053236R
Draaibaar draadstuk 7/8UNF	7/8UNF	24	29 mm	855053237R
Draaibaar draadstuk 3/8UNF links	3/8UNF links	10	13 mm	855053232L
Draaibaar draadstuk 5/8UNF links	5/8UNF links	17	22 mm	855053236L
Draaibaar draadstuk 7/8UNF links	7/8UNF links	24	32 mm	855053237L



# 8.5.0

**Dubbel nippel**  
**Draad nippel**  
**Huls met schroefdraad**

Double threaded adapter  
Threaded nipple  
Threaded coupler

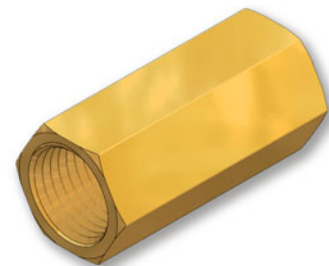
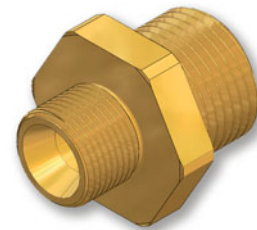
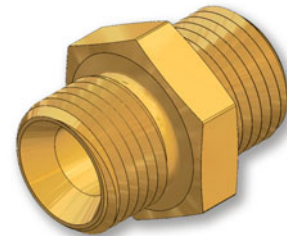

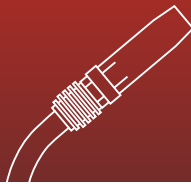
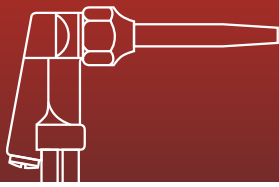

## 8.5.1

### Dubbel nippel

Male double threaded coupler

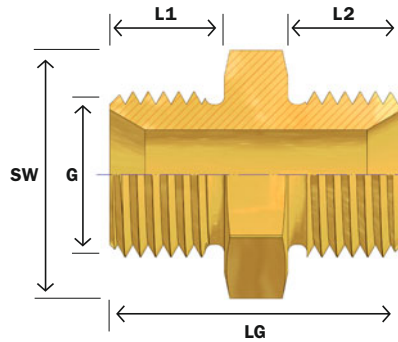

G: Schroefdraad, SW: Sleutelbreedte, L1/2: Lengte schroefdraad, LG: Totale lengte

Artikelbeschrijving	G	SW	LG	L1	L2	Bestelnummer
Dubbel nippel M10x1r	M10x1	14	21 mm			855058022R
Dubbel nippel M10x1r SW10	M10x1	10	24,5 mm	10 mm	10 mm	855058022R1
Dubbel nippel M12x1r	M12x1	12	28 mm	10 mm	10 mm	855058024R-1
Dubbel nippel G1/8"	G1/8"	14	21 mm	7,8 mm	7,8 mm	855058011R
Dubbel nippel G1/4"	G1/4"	17	23 mm	10 mm	10 mm	855058012R
Dubbel nippel G1/4" lang	G1/4"	17	42 mm	14 mm	22 mm	855058012R-L
Dubbel nippel G3/8"	G3/8"	19	27 mm	11 mm	11 mm	855058013R
Dubbel nippel 9/16UNF	9/16UNF	17	28 mm	11 mm	11 mm	855058035R
Dubbel nippel 9/16UNF links	9/16UNF links	17	28 mm	11 mm	11 mm	855058035L

## 8.5.2

### Draad nippel

Male double threaded coupler

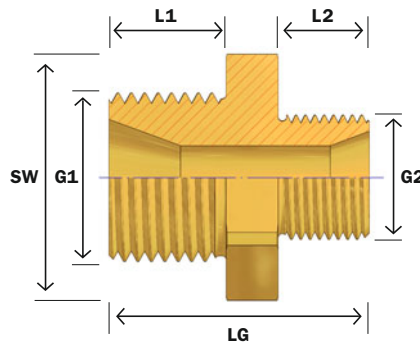

G: Schroefdraad, SW: Sleutelbreedte, L1/2: Lengte schroefdraad, LG: Totale lengte

Artikelbeschrijving	G1	L1	SW	G2	L2	LG	Bestelnummer
Draad nippel G1/4"buitendr. – G3/8"buitendr.	G1/4"	12 mm	17	G3/8"	13,5 mm	35,5 mm	855058212R13R
Draad nippel G1/8"buitendr. – G1/4"buitendr.	G1/8"	7 mm	17	G1/4"	9 mm	20 mm	855058211R12R
Draad nippel G1/8"buitendr. – G3/8"buitendr.	G1/8"	7 mm	19	G3/8"	11 mm	23 mm	855058211R13R
Draad nippel G1/4"buitendr. – M10x1buitendr.	G1/4"	9 mm	17	M10x1	9 mm	23 mm	855058212R22R
Draad nippel G1/4"buitendr. – M12x1buitendr.	G1/4"	11 mm	17	M12x1	11 mm	28 mm	855058212R24R
Draad nippel G3/8"buitendr. – M10x1buitendr.	G3/8"	20 mm	19	M10x1	10 mm	42 mm	855058213R22R
Draad nippel M10x1buitendr. – M12x1buitendr.	M10x1	10 mm	12	M12x1	11 mm	26 mm	855058222R24R



## 8.5.3

### Huls met schroefdraad, doorgaande schroefdraad

Female threaded coupler

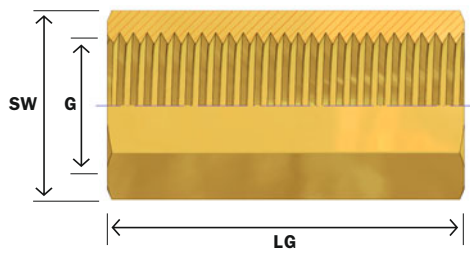

**G:** Schroefdraad, **SW:** Sleutelbreedte, **LG:** Wartel lengte

Artikelbeschrijving	G	SW	LG	Bestelnummer
Huls met schroefdraad 1/4UNF	1/4UNF	8	14 mm	855058131R
Huls met schroefdraad M10x1	M10x1	12	26 mm	855058122R

## 8.5.4

### Huls met schroefdraad, schroefdraad met konus dichting

Female threaded coupler

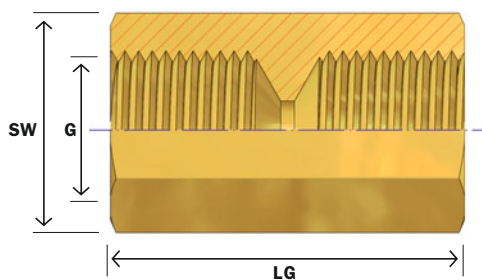

**G:** Schroefdraad, **SW:** Sleutelbreedte, **LG:** Wartel lengte

Artikelbeschrijving	G	SW	LG	Bestelnummer
Huls met schroefdraad 3/8UNF (E)	3/8UNF	14	25,5 mm	855058132R-11

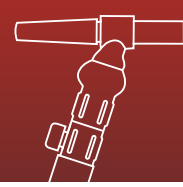
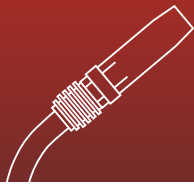
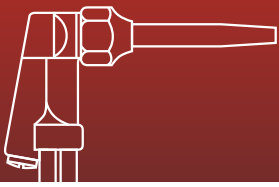

# 8.6.0

## Adapter Reduceer stukken

Reducing adapter male/female

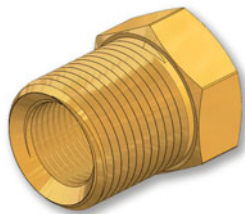
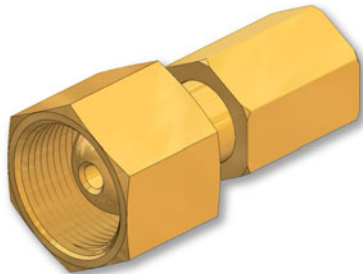
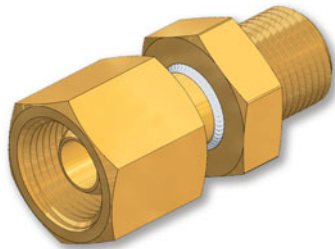

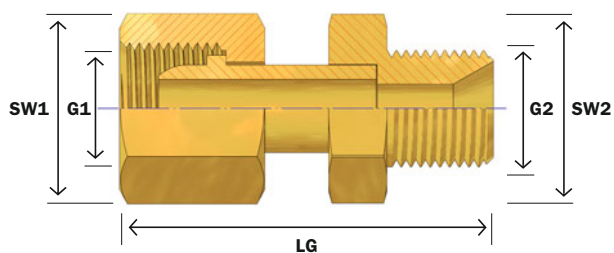
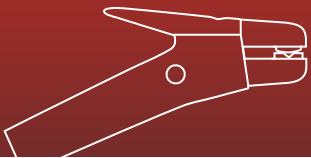

**G:** Schroefdraad, **SW:** Sleutelbreedte, **LG:** Totale lengte

## 8.6.1

### Adapter met wartel/buitendraad

Reducing adapter male/female with swivel nut

Artikelbeschrijving	G1	SW1	G2	SW2	LG	Bestelnummer
Adapter G3/8"wartel(K) – G1/4"buitendraad	G3/8"	19	G1/4"	14	44 mm	855058513R12R
Adapter G3/8"wartel(K) – M12x1buitendraad	G3/8"	19	M12x1	17	42,5 mm	855058513R24R
Adapter M10x1wartel(K) – G1/8"buitendraad	M10x1	14	G1/8"	14	40 mm	855058522R11R

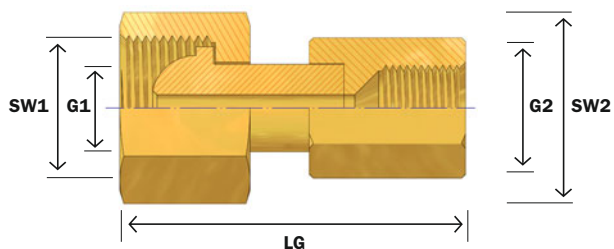

**G:** Schroefdraad, **SW:** Sleutelbreedte, **LG:** Totale lengte

## 8.6.2

### Adapter met wartel/binnendraad

Reducing adapter female/female with swivel nut

Artikelbeschrijving	G1	SW1	G2	SW2	LG	Bestelnummer
Adapter G1/8"wartel(K) – 3/8UNFbinnendraad(E)	G1/8"	12	3/8UNF	11,4	45,5 mm	855058611R32R
Adapter G1/4"wartel(K) – 3/8UNFbinnendraad(E)	G1/4"	17	3/8UNF	14	37,5 mm	855058612R32R
Adapter G3/8"wartel(K) – 3/8UNFbinnendraad(E)	G3/8"	19	3/8UNF	14	38,5 mm	855058613R32R

## 8.6.3

### Reduceer stuk

Reducing adapter

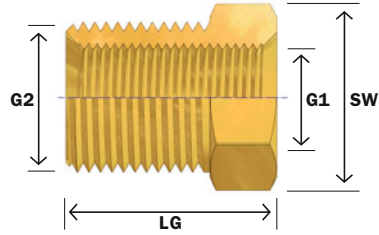

G: Schroefdraad, SW: Sleutelbreedte, LG: Totale lengte

#### Artikelbeschrijving

Artikelbeschrijving	G1	G2	SW	LG	Bestelnummer
Reduceer stuk G1/8" binnendr. – G1/4" buitendraad	G1/8"	G1/4"	14	16 mm	855058411R12R
Reduceer stuk G1/8" binnendr. – G3/8" buitendraad	G1/8"	G3/8"	19	13 mm	855058411R13R
Reduceer stuk G1/4" binnendr. – G3/8" buitendraad	G1/4"	G3/8"	19	13 mm	855058412R13R

## 8.6.4

### Adapter toortslichaam met buitendraad/buitendraad

Reducing adapter male/male

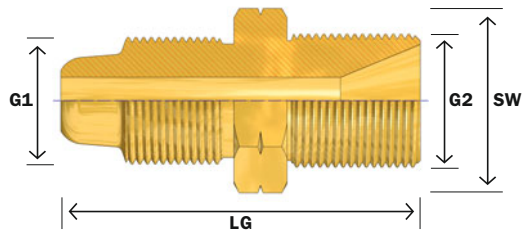

G: Schroefdraad, SW: Sleutelbreedte, LG: Totale lengte

#### Artikelbeschrijving

Artikelbeschrijving	G1	SW	G2	LG	Bestelnummer
Adapter 3/8UNFLAG(K) – M10x1buitendraad(E)	3/8UNF links	12	M10x1	27 mm	855058832L22R1
Adapter 3/8UNFLAG(K) – M12x1buitendraad(E)	3/8UNF links	12	M12x1	27 mm	855058832L24R1
Adapter 3/8UNFbuitendraad(K) – G1/8buitendraad(E)	3/8UNF	12	G1/8"	27 mm	855058832R11R1
Adapter 3/8UNFbuitendraad(K) – M10x1buitendraad	3/8UNF	12	M10x1	27 mm	855058832R22R1



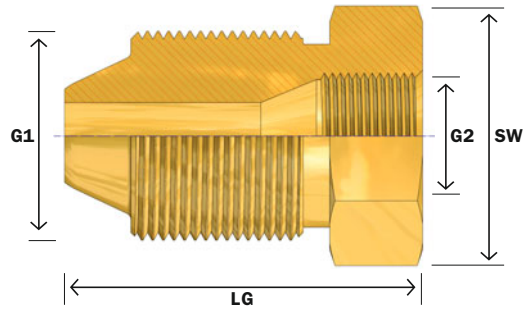

G: Schroefdraad, SW: Sleutelbreedte, LG: Totale lengte

## 8.6.5

### Adapter toortslichaam met buitendraad/binnendraad

Reducing adapter male/female

Artikelbeschrijving	G1	SW	G2	LG	Bestelnummer
Adapter 5/8UNFbuitendraad(K) – 3/8UNFbinnendraad(E)	5/8UNF	17	3/8UNF	27,5 mm	855058836R32R2

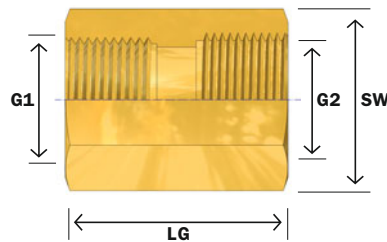

G: Schroefdraad, SW: Sleutelbreedte, LG: Totale lengte

## 8.6.6

### Adapter toortslichaam met binnendraad/binnendraad

Reducing adapter female/female

Artikelbeschrijving	G1	SW	G2	LG	Bestelnummer
Adapter 3/8UNFbinnendraad – G1/8"binnendraad	3/8UNF	12	G1/8	17 mm	855058832R11R3

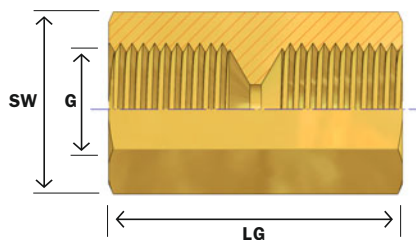

G: Schroefdraad, SW: Sleutelbreedte, LG: Wartel lengte

## 8.6.7

### Huls met schroefdraad, schroefdraad met konus dichting

Female threaded coupler

Artikelbeschrijving	G	SW	LG	Bestelnummer
Huls met schroefdraad 3/8UNF (E)	3/8UNF	14	25,5 mm	855058132R-11

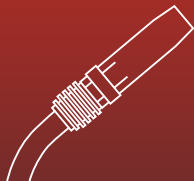
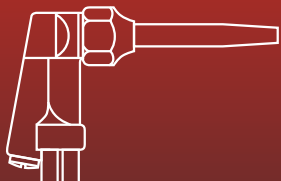

# 8.7.0

## Steeknippel manlijk

Quickconnect nipple  
Quickconnect coupler

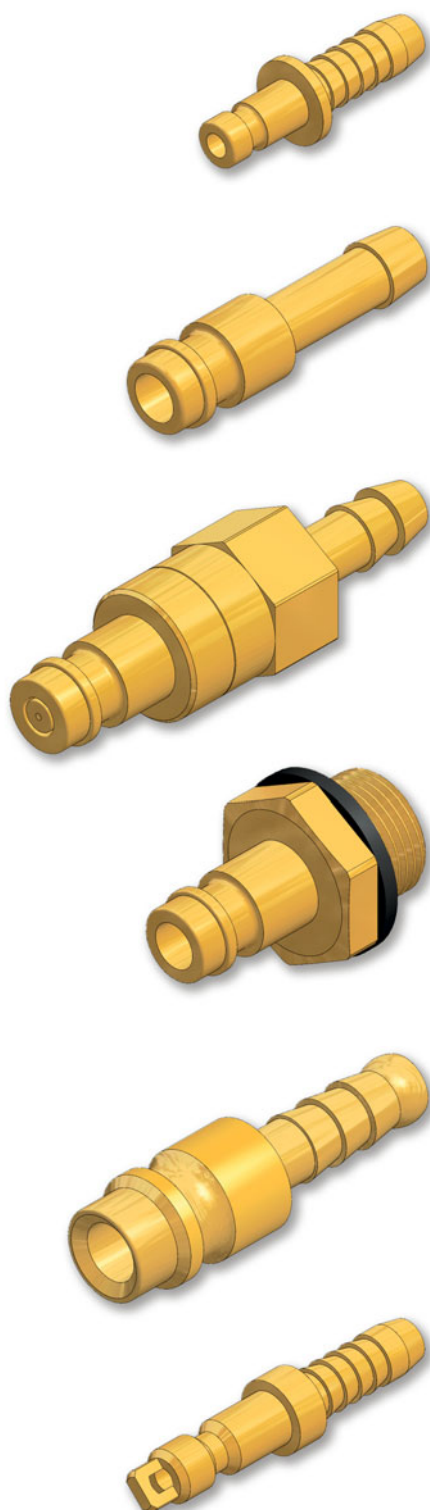

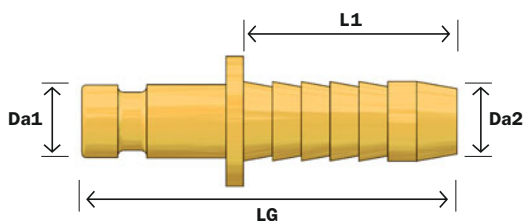
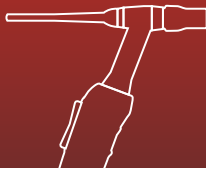
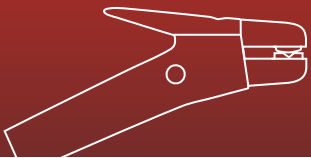

# 8.7.1

## Steeknippel manlijk type 20

Quickconnect nipple typ 20

**Da1:** Buitendiameter, **L1:** Lengte slangaansluiting, **Da2:** Diameter slangaansluiting, **LG:** Totale lengte

Artikelbeschrijving	Da1	Da2	L1	LG	Bestelnummer
Steeknippel manlijk type 20# NW2,7 5 mm	5 mm	5 mm	12 mm	22 mm	85506201305

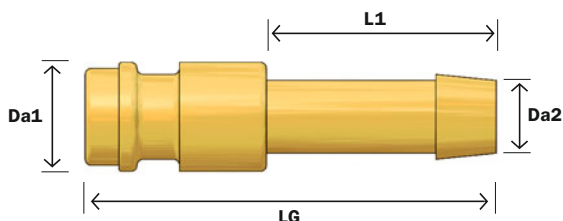

# 8.7.2

## Steeknippel manlijk type 21

Quickconnect nipple typ 21

**Da1:** Buitendiameter, **L1:** Lengte slangaansluiting, **Da2:** Diameter slangaansluiting, **LG:** Totale lengte

Artikelbeschrijving	Da1	Da2	L1	LG	Bestelnummer
Steeknippel manlijk type21# NW5 4 mm	9 mm	4 mm	17 mm	32 mm	85506211304
Steeknippel manlijk type21# NW5 5 mm	9 mm	5 mm	19 mm	34 mm	85506211305
Steeknippel manlijk type21# NW5 6 mm	9 mm	6 mm	19 mm	34 mm	85506211306
Steeknippel manlijk type21# NW5 8 mm	9 mm	8 mm	17 mm	36 mm	85506211308
Steeknippel manlijk type21# NW5 9 mm	9 mm	9 mm	17 mm	36 mm	85506211309

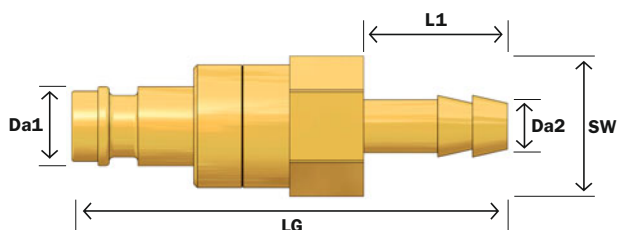

# 8.7.3

## Steeknippel manlijk type 21 BA, zelfsluitend

Quickconnect nipple typ 21BA with closing valve

**Da1:** Buitendiameter, **L1:** Lengte slangaansluiting, **Da2:** Diameter slangaansluiting, **SW:** Sleutelbreedte, **LG:** Totale lengte

Artikelbeschrijving	SW	Da1	Da2	L1	LG	Bestelnummer
Steeknippel manlijk type21#BA NW5 4 mm	14	9 mm	4 mm	17 mm	50 mm	85506212304
Steeknippel manlijk type21#BA NW5 6 mm	14	9 mm	6 mm	17 mm	50 mm	85506212306
Steeknippel manlijk type21#BA NW5 8 mm	14	9 mm	8 mm	17 mm	50 mm	85506212308

## 8.7.4

### Steeknippel met draadeinde type 21

Quickconnect coupler typ 21  
with thread

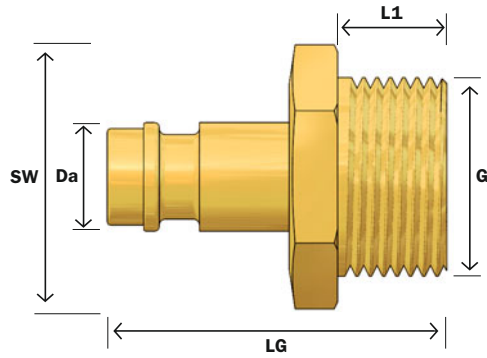

G: Schroefdraad, SW: Sleutelbreedte, Da: Buitendiameter, L1: Lengte slangaansluiting, LG: Totale lengte

#### Artikelbeschrijving

	G	SW	Da1	L1	LG	Bestelnummer
Steeknippel type21# NW5 G1/8"binnendraad	G1/8"	14	9 mm	11 mm	25 mm	855062113111R
Steeknippel type21# NW5 G1/4"buitendraad	G1/4"	17	9 mm	7 mm	27,5 mm	855062113212R
Steeknippel type21# NW5 G3/8"buitendraad	G3/8"	19	9 mm	9 mm	28 mm	855062113213R

## 8.7.5

### Steeknippel type 26

Quickconnect nipple typ 26

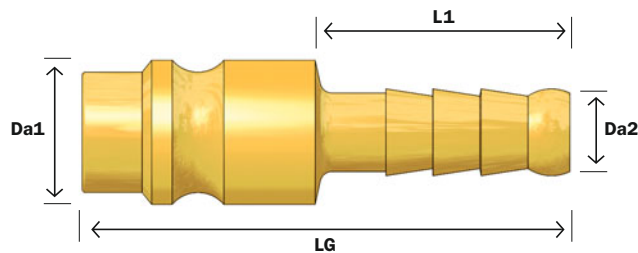

Da1: Buitendiameter, L1: Lengte slangaansluiting, Da2: Diameter slangaansluiting, LG: Totale lengte

#### Artikelbeschrijving

	Da1	Da2	L1	LG	Bestelnummer
Steeknippel type26# NW7,2 4 mm	12 mm	4 mm	21 mm	40 mm	85506261304
Steeknippel type26# NW7,2 6 mm	12 mm	6 mm	20 mm	40 mm	85506261306
Steeknippel type26# NW7,2 8 mm	12 mm	8 mm	25 mm	48 mm	85506261308

## 8.7.6

### Steeknippel type 50

Quickconnect nipple typ 50

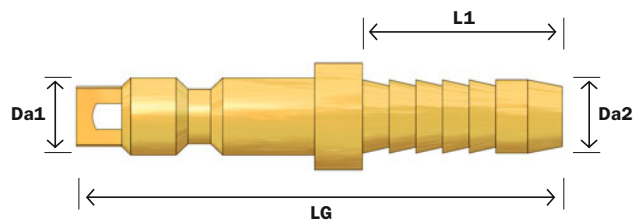

Da1: Buitendiameter, L1: Lengte slangaansluiting, Da2: Diameter slangaansluiting, LG: Totale lengte

#### Artikelbeschrijving

	Da1	Da2	L1	LG	Bestelnummer
Steeknippel type50# NW2,5 5 mm	6 mm	5 mm	15 mm	36 mm	8550650305

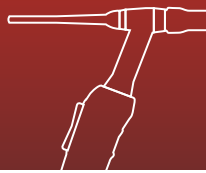

**ROHRMAN**  
SCHWEISSTECHNIK

# 8.8.0

**Slangansluitingen**

Hose nipple

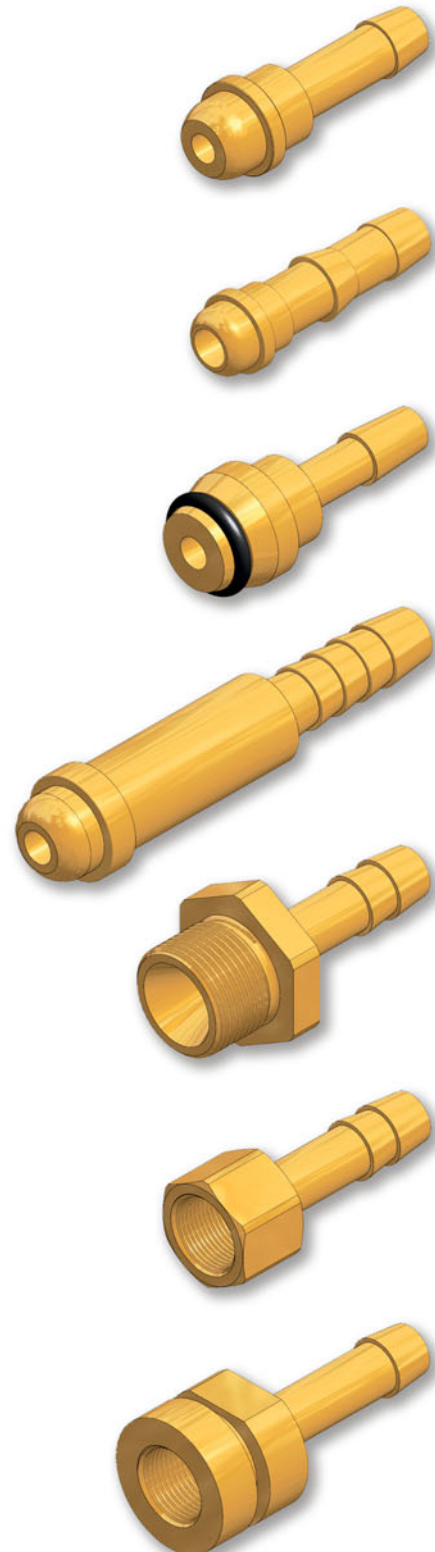

# 8.8.1

## Slangaansluitingen, kort

Hose nipple short

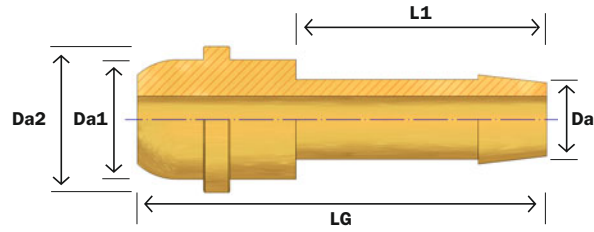

K: Konus, Da: Buitendiameter, L: Lengte aansluiting, LG: Totale lengte

Artikelbeschrijving	K	Da1	Da2	Da	L1	LG	Bestelnummer
Slangaansluiting v. M6x0,5 4 mm	M6	4 mm	5 mm	3,25 mm	14 mm	14 mm	855071120040
Slangaansluiting v. M8x1 5 mm	M8	5 mm	6,5 mm	4,5 mm	22 mm	22 mm	855071121050
Slangaansluiting v. G1/8", M10 4 mm	G1/8"/M10	6 mm	8 mm	4 mm	17 mm	17 mm	855071111040
Slangaansluiting v. G1/8", M10 5 mm	G1/8"/M10	6 mm	8 mm	5 mm	19 mm	19 mm	855071111050
Slangaansluiting v. G1/8", M10 6 mm	G1/8"/M10	6,5 mm	8,5 mm	6 mm	18 mm	18 mm	855071111060
Slangaansluiting v. G1/4", M12 4 mm	G1/4"/M12	9 mm	11 mm	4 mm	16,5 mm	16,5 mm	855071112040
Slangaansluiting v. G1/4", M12 5 mm	G1/4"/M12	9 mm	11 mm	5 mm	19 mm	19 mm	855071112050
Slangaansluiting v. G1/4", M12 6 mm	G1/4"/M12	9 mm	11 mm	6 mm	19 mm	19 mm	855071112060
Slangaansluiting v. G1/4", M12 8 mm	G1/4"/M12	9 mm	11 mm	8 mm	21 mm	21 mm	855071112080
Slangaansluiting v. G1/4", M12 9 mm	G1/4"/M12	9 mm	9 mm	9 mm	25 mm	25 mm	855071112090
Slangaansluiting v. G3/8" 4 mm	G3/8"	12 mm	14,5 mm	4 mm	19 mm	19 mm	855071113040
Slangaansluiting v. G3/8" 5 mm	G3/8"	12 mm	14,5 mm	5 mm	19 mm	19 mm	855071113050
Slangaansluiting v. G3/8" 6 mm	G3/8"	12 mm	14,5 mm	6 mm	19 mm	19 mm	855071113060
Slangaansluiting v. G3/8" 8 mm	G3/8"	12 mm	14,5 mm	8 mm	20 mm	20 mm	855071113080

# 8.8.2

## Slangaansluitingen, lang

Hose nipple long

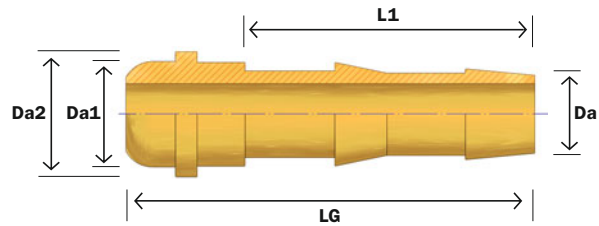

K: Konus, Da: Buitendiameter, L: Lengte aansluiting, LG: Totale lengte

Artikelbeschrijving	K	Da1	Da2	Da	L1	LG	Bestelnummer
Slangaansluiting v. G1/4", M12 6 mm lang (47 mm)	G1/4"/M12	9 mm	11 mm	7,5 mm	35 mm	47 mm	855071112060-L
Slangaansluiting v. G3/8", 6 mm lang (47 mm)	G3/8"	12 mm	14,5 mm	6 mm	33 mm	47 mm	855071113060-L
Slangaansluiting v. G3/8", 10 mm lang (47 mm)	G3/8"	12 mm	14,5 mm	10 mm	33 mm	47 mm	855071113100-L

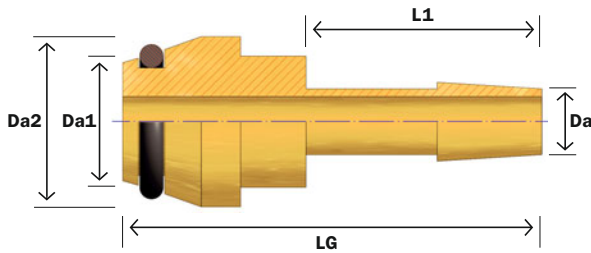

## 8.8.3

### Slangaansluitingen met O-ring

Hose nipple with O-ring

K: Konus, Da: Buitendiameter, L: Lengte aansluiting, LG: Totale lengte

Artikelbeschrijving	K	Da1	Da2	Da	L1	LG	Bestelnummer
Slangaansluiting voor G1/4"+O-ring 5 mm	G1/4"	9 mm	11 mm	5 mm	33 mm	47 mm	855071112050-F
Slangaansluiting voor G1/4"+O-ring 6 mm	G1/4"	9 mm	11 mm	6 mm	33 mm	47 mm	855071112060-F
Slangaansluiting voor G3/8"+O-ring 5 mm	G3/8"	10 mm	13 mm	5 mm	18 mm	32 mm	855071113050-F

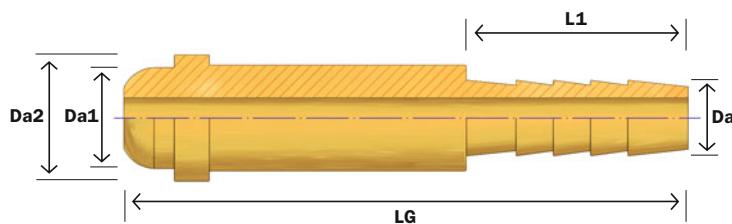

## 8.8.4

### Slangaansluitingen voor draaibaar draadstuk

Hose nipple

K: Konus, Da: Buitendiameter, L: Lengte aansluiting, LG: Totale lengte

Artikelbeschrijving	K	Da1	Da2	Da	L1	LG	Bestelnummer
Slangaansluiting v. 5/8UNFschroefdr. 4 mm	5/8UNF	11,3 mm	14 mm	4 mm	20 mm	50 mm	855071236040
Slangaansluiting v. 5/8UNFschroefdr. 5 mm	5/8UNF	11,3 mm	14 mm	5 mm	20 mm	50 mm	855071236050
Slangaansluiting v. 5/8UNFschroefdr. 6 mm	5/8UNF	11,3 mm	14 mm	6 mm	20 mm	50 mm	855071236060
Slangaansluiting v. 5/8UNFschroefdr. 10 mm	5/8UNF	11,3 mm	14 mm	9,25 mm	20 mm	50 mm	855071236100

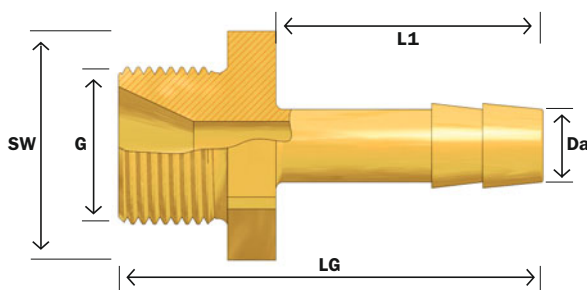

## 8.8.5

### Slangaansluitingen met buitendraad

Hose nipple with male thread RH

G: Schroefdraad, SW: Sleutelbreedte, Da: Buitendiameter, L1: Lengte aansluiting, LG: Totale lengte

Artikelbeschrijving	G	SW	Da	L1	LG	Bestelnummer
Slangaansluiting G1/4"buitendraad 6 mm	G1/4"	17	6 mm	22 mm	35 mm	855072212060
Slangaansluiting M10x1buitendraad 6 mm	M10x1	14	6 mm	17 mm	28 mm	855072222060

## 8.8.6

### Slangaansluitingen met binnendraad

Hose nipple with female thread

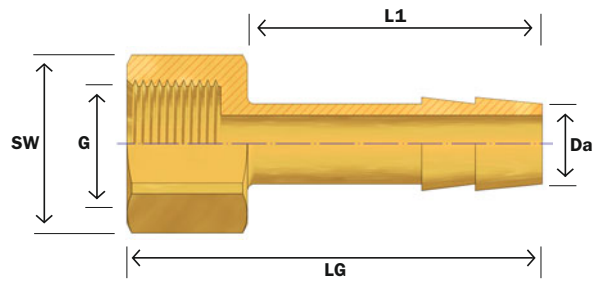

G: Schroefdraad, SW: Sleutelbreedte, Da: Buitendiameter, L1: Lengte aansluiting, LG: Totale lengte

#### Artikelbeschrijving

Artikelbeschrijving	G	SW	Da	L1	LG	Bestelnummer
Slangaansluiting G1/8" binnendraad 6 mm	G1/8"	12				855072111060
Slangaansluiting G1/8" binnendraad 8 mm	G1/8"	12	8 mm	22 mm	31 mm	855072111080

## 8.8.7

### Gasaansluiting met binnendraad met kerf om in het metaalhuis van de machine te hangen

Hose nipple with female thread for locking in sheetmetal case

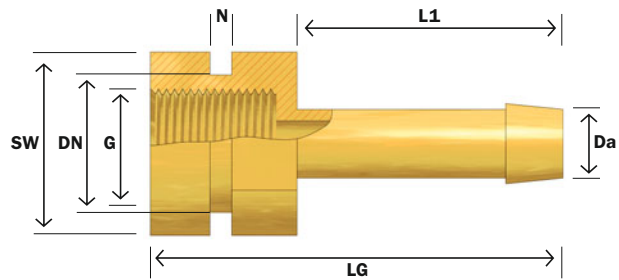

G: Schroefdraad, SW: Sleutelbreedte, DN: Diameter kerf, N: Kerf, Da: Buitendiameter, L1: Lengte aansluiting, LG: Totale lengte

#### Artikelbeschrijving

Artikelbeschrijving	G	SW	DN	N	Da	L1	LG	Bestelnummer
Slangaansluiting G1/8" binnendraad+kerf 6 mm	G1/8"	14	12 mm	2 mm	6 mm	24 mm	27 mm	855072111060S





**ROHRMAN**  
SCHWEISSTECHNIK

# 8.9.0

**Slangverbinder**

Hose connector



## 8.9.1

### Slangverbinder messing, kort

Hose connector, brass short

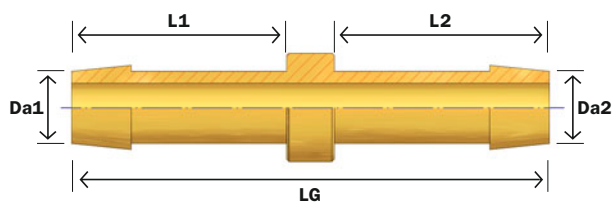

Da: Buitendiameter, L: Lengte aansluiting, LG: Totale lengte

Artikelbeschrijving	Da1	L1	Da2	L2	LG	Bestelnummer
Slangverbinder messing 6 mm	6 mm	18 mm	6 mm	18 mm	40 mm	85507006M

## 8.9.2

### Slangverbinder messing, lang

Hose connector, brass long

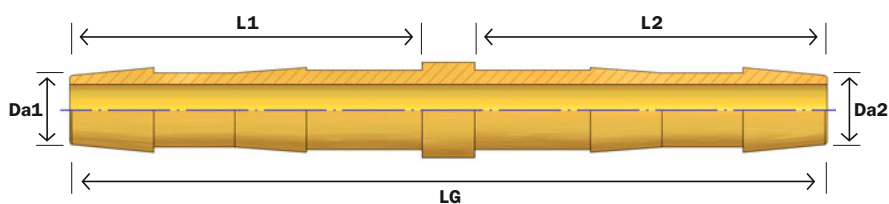

Da: Buitendiameter, L: Lengte aansluiting, LG: Totale lengte

Artikelbeschrijving	Da1	L1	Da2	L2	LG	Bestelnummer
Slangverbinder messing 6 mm	6 mm	33,5 mm	6 mm	33,5 mm	72 mm	85507006M-L
Slangverbinder messing 8 mm	8 mm	33,5 mm	8 mm	33,5 mm	72 mm	85507008M-L
Slangverbinder messing 10 mm	10 mm	33,5 mm	10 mm	33,5 mm	72 mm	85507010M-L

## 8.9.3

### Slangverbinder messing voor verschillende slangafmetingen

Hose connector for different hose diameter

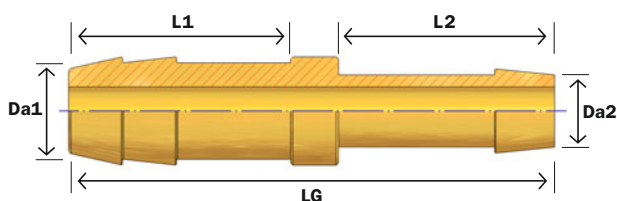

Da: Buitendiameter, L: Lengte aansluiting, LG: Totale lengte

Artikelbeschrijving	Da1	L1	Da2	L2	LG	Bestelnummer
Slangverbinder messing 6 mm/8 mm	8 mm	20 mm	6 mm	20 mm	49 mm	8550700608M

## 8.9.4

### Slangverbinder plastic

Hose connector plastic

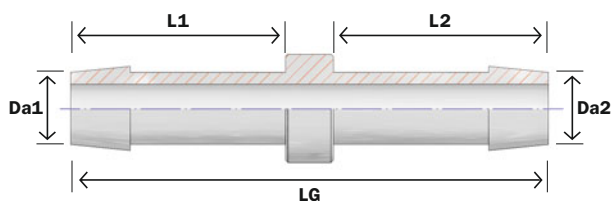

Da: Buitendiameter, L: Lengte aansluiting, LG: Totale lengte

Artikelbeschrijving	Da1	L1	Da2	L2	LG	Bestelnummer
Slangverbinder plastic 4 mm	4 mm	15 mm	4 mm	15 mm	35 mm	85507004K
Slangverbinder plastic 6 mm	6 mm	20 mm	6 mm	20 mm	49 mm	85507006K
Slangverbinder plastic 90° 6 mm	4 mm	14 mm	4 mm	14 mm	35 mm	85507066K90



# 8.10.0

## **Krimphuls Een oor slangklem**

Ferrule  
1-ear-clamp  
Hoseclamp

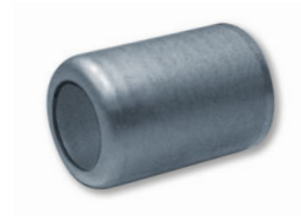

# 8.10.1

## Krimphuls

Ferrule

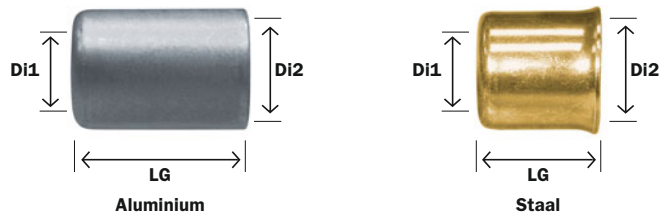

Di1: Diameter boring, Di2: Binnendiameter huls, LG: Totale lengte

Artikelbeschrijving	Materiaal	Binnen Ø huls	Ø boring	Lengte	Bestelnummer
Krimphuls A300	Aluminium	8,8 mm	5,5 mm	12,7 mm	85519A088
Krimphuls A400L	Aluminium	10,1 mm	6,8 mm	18,2 mm	85519A101
Krimphuls A450L	Aluminium	11,6 mm	8,0 mm	18,0 mm	85519A116
Krimphuls A475L	Aluminium	12,1 mm	8,4 mm	18,2 mm	85519A120
Krimphuls A500L	Aluminium	12,6 mm	8,5 mm	18,0 mm	85519A126
Krimphuls A525L	Aluminium	13,3 mm	10,5 mm	18,0 mm	85519A133
Krimphuls A550L	Aluminium	14,1 mm	10,3 mm	18,3 mm	85519A140
Krimphuls A575L	Aluminium	14,6 mm	10,0 mm	24,5 mm	85519A146
Krimphuls A600L	Aluminium	15,2 mm	11,5 mm	24,7 mm	85519A152
Krimphuls A625L	Aluminium	15,9 mm	11,5 mm	24,7 mm	85519A159
Krimphuls A650L	Aluminium	16,4 mm	12,0 mm	24,7 mm	85519A160
Krimphuls S090	Staal gegalvaniseerd	9,0 mm	6,2 mm	17,0 mm	85519S090
Krimphuls S100	Staal gegalvaniseerd	10,0 mm	6,2 mm	15,0 mm	85519S100
Krimphuls S110	Staal gegalvaniseerd	11,0 mm	7,2 mm	15,0 mm	85519S110
Krimphuls S120	Staal gegalvaniseerd	12,0 mm	7,8 mm	20,0 mm	85519S120
Krimphuls S125	Staal gegalvaniseerd	12,5 mm	7,5 mm	15,0 mm	85519S125
Krimphuls S130	Staal gegalvaniseerd	13,0 mm	10,0 mm	17,0 mm	85519S130
Krimphuls S140	Staal gegalvaniseerd	14,0 mm	10,0 mm	15,0 mm	85519S140
Krimphuls S165	Staal gegalvaniseerd	16,5 mm	12,0 mm	20,0 mm	85519S165
Krimphuls S175	Staal gegalvaniseerd	17,5 mm	12,0 mm	20,0 mm	85519S175
Krimphuls S210	Staal gegalvaniseerd	21,0 mm	16,5 mm	31,0 mm	85519S210
Krimphuls S280	Staal gegalvaniseerd	28,0 mm	19,5 mm	32,0 mm	85519S280

# 8.10.2

## Krimphuls

Ferrule

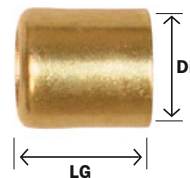

Di: Binnendiameter huls, LG: Totale lengte

Artikelbeschrijving	Materiaal	Binnen Ø huls	Lengte	Bestelnummer
Krimphuls S080R	Staal gegalvaniseerd	8,0 mm	10,0 mm	85519S080R
Krimphuls S090R	Staal gegalvaniseerd	9,0 mm	10,0 mm	85519S090R
Krimphuls S100R	Staal gegalvaniseerd	10,0 mm	10,0 mm	85519S100R
Krimphuls S110R	Staal gegalvaniseerd	11,0 mm	11,0 mm	85519S110R

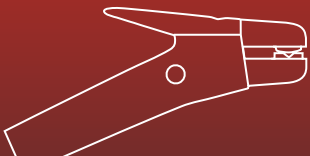

## 8.10.3

### Een oor klem

1-ear-clamp

Artikelbeschrijving	Spanbereik	Bestelnummer
Een oor klem met inlegring 7,0 ER	5,6 mm–6,5 mm	855200070
Een oor klem met inlegring 7,5 ER	5,9 mm–7,0 mm	855200075
Een oor klem met inlegring 8,3 ER	6,6 mm–7,8 mm	855200083
Een oor klem met inlegring 8,7 ER	7,0 mm–8,2 mm	855200087
Een oor klem met inlegring 9,0 ER	7,0 mm–8,5 mm	855200090
Een oor klem met inlegring 9,5 ER	7,5 mm–9,0 mm	855200095
Een oor klem met inlegring 10,0 ER	8,0 mm–9,5 mm	855200100
Een oor klem met inlegring 10,5 ER	8,5 mm–10,0 mm	855200105
Een oor klem met inlegring 11,3 ER	9,1 mm–10,8 mm	855200113
Een oor klem met inlegring 11,8 ER	9,6 mm–11,3 mm	855200118
Een oor klem met inlegring 12,0 ER	9,5 mm–11,5 mm	855200120
Een oor klem met inlegring 12,8 ER	10,3 mm–12,3 mm	855200128
Een oor klem met inlegring 13,3 ER	10,6 mm–12,6 mm	855200133
Een oor klem met inlegring 13,8 ER	11,1 mm–13,1 mm	855200138
Een oor klem met inlegring 14,0 ER	11,3 mm–13,3 mm	855200140
Een oor klem met inlegring 14,5 ER	11,8 mm–13,8 mm	855200145
Een oor klem met inlegring 15,0 ER	12,3 mm–14,3 mm	855200150

## 8.10.4

### Een oor klem

1-ear-clamp

Artikelbeschrijving	Spanbereik	Bestelnummer
Een oor klem met inlegring 8,5	7,5 mm–8,5 mm	855201085
Een oor klem met inlegring 9,5	8,2 mm–9,5 mm	855201095
Een oor klem met inlegring 10,5	9,0 mm–10,5 mm	855201105
Een oor klem met inlegring 11,5	10,0 mm–11,5 mm	855201115
Een oor klem met inlegring 12,5	10,5 mm–12,5 mm	855201125
Een oor klem met inlegring 13,3	11,5 mm–13,3 mm	855201133
Een oor klem met inlegring 15,3	13,0 mm–15,3 mm	855201153
Een oor klem met inlegring 17,3	15,0 mm–17,3 mm	855201173



## 8.10.5

### Slangklem

Hoseclamp

Artikelbeschrijving	Breedte	Spanbereik	Bestelnummer
Slangklem 22/B09 gemarkeerd	9 mm	12–22 mm	8552052209
Slangklem 40/B12 gemarkeerd	12 mm	25–40 mm	8552054012
Slangklem 45/B12 gemarkeerd	12 mm	30–45 mm	8552054512
Slangklem 50/B12 gemarkeerd	12 mm	32–50 mm	8552055012
Slangklem 60/B12 gemarkeerd	12 mm	40–60 mm	8552056012

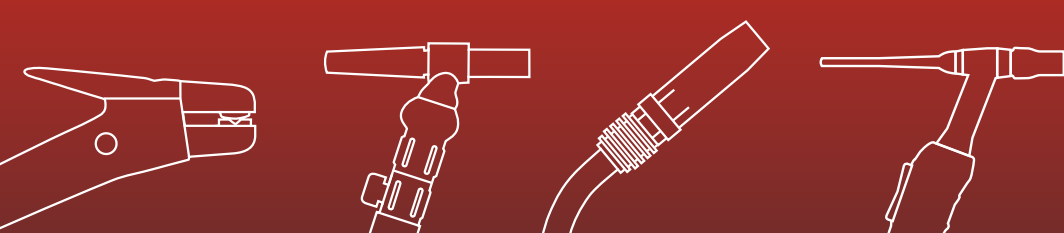

Voor verdere informatie kunt U zich aan Uw handelaar wenden.

