

WeldTec®

Quartz TIG Nozzles

Clear quartz glass nozzles for WeldTec® and most standard torches.

- Better weld puddle visibility
- Higher heat resistance
- No thermal shock breakage
- Better laminar gas coverage

TEC introduced the glass nozzles to TIG torches back in 1955. The original nozzles were made from Pyrex® grade glass.

These modern fused quartz nozzles offer superior temperature and thermal shock resistance, surpassing Pyrex®, lava and the pink ceramic nozzles for performance.

Now you can use these quartz nozzles on most TIG torches using a simple adapter ring. Available in several orifice sizes and several lengths to suit your job requirements.



Made in America.



Standard 17, 18, 26
collet body



Standard 9, 20, 25
collet body













WT-9, 20 with gas lens



WT-24 with gas lens

ORDERING INFORMATION

TORCH SERIES	DESCRIPTION	PART NO.	QUARTZ NOZZLE	SIZE	PART NO.	
WT-17, 18, 26	ADAPTER RING  (GOLD COLOR)	10NQA	 #7L  #9L	7/16	10NQ-7L	
	NOZZLE GASKET 	10NQG		9/16	10NQ-9L	
WT-9, 20, 24, 25 SW-320	ADAPTER RING  (SILVER COLOR)	13NQA	STANDARD LONG  #5  #5L  #7  #7L  #9  #9L	5/16	STANDARD	
	GAS LENS 	45V43NQ (1/16)		7/16		13NQ-5
	GAS LENS 	45V44NQ (3/32)		9/16		13NQ-7
		45V45NQ (1/8)		5/16	13NQ-9	
	NOZZLE GASKET  (USE WITH WT-24 SERIES)	53N66		7/16	LONG	
				9/16	13NQ-5L	
			10NQ-7L			
			10NQ-9L			

Specifications subject to change without notice.

WeldTec® Quartz TIG Nozzles

WT-9, 20, 25 TORCH SERIES

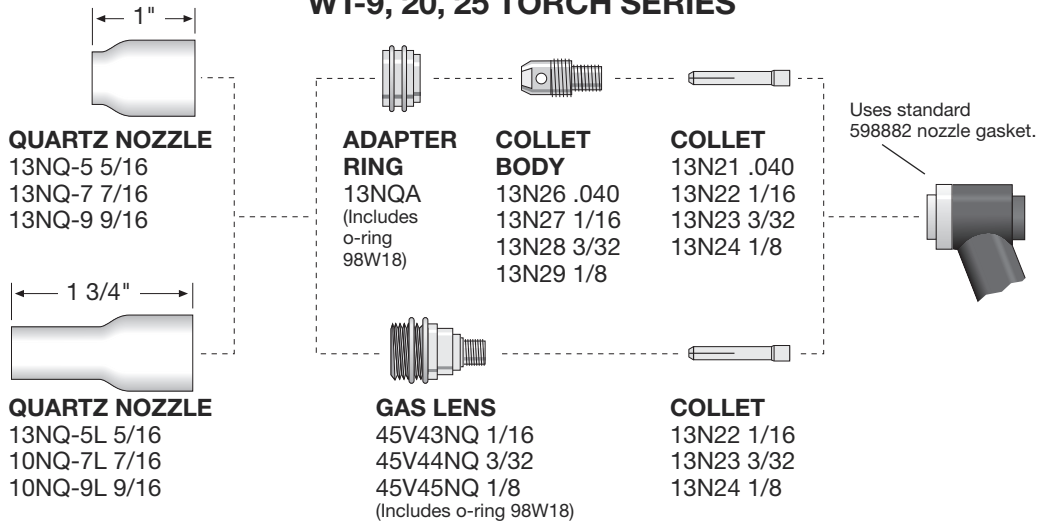

WT-17, 18, 26 TORCH SERIES

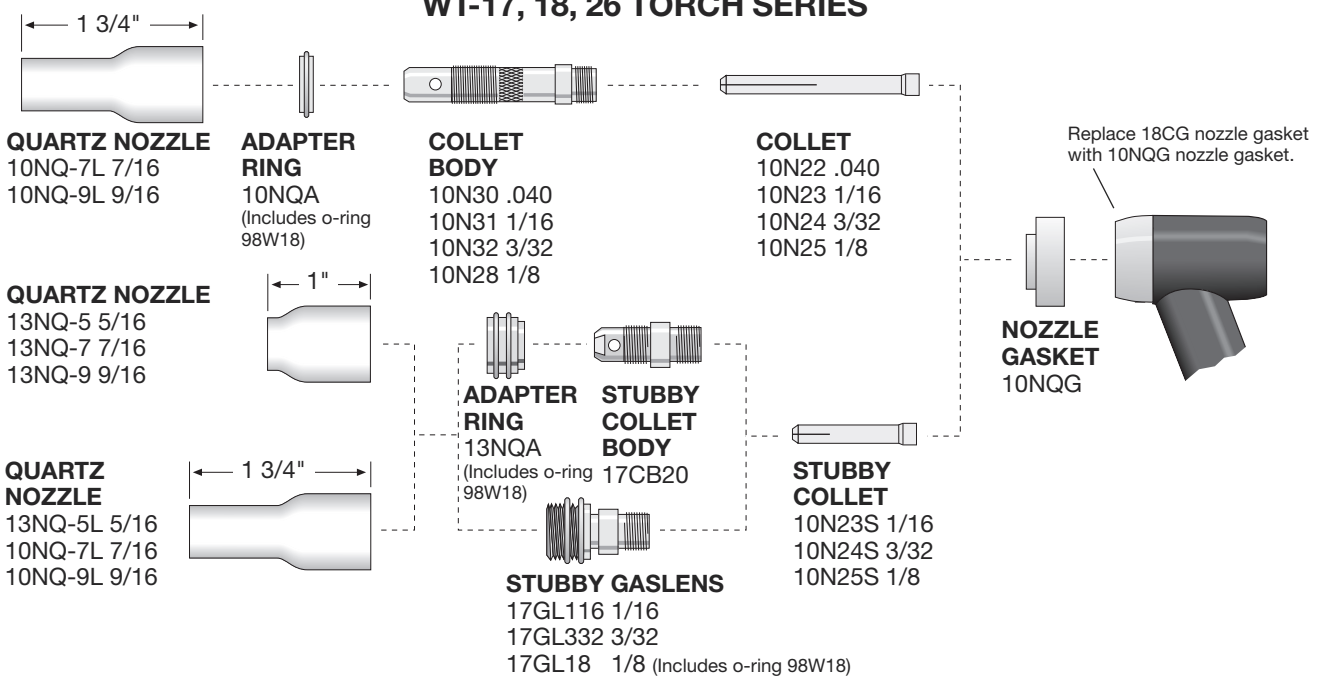

WT-24 TORCH SERIES

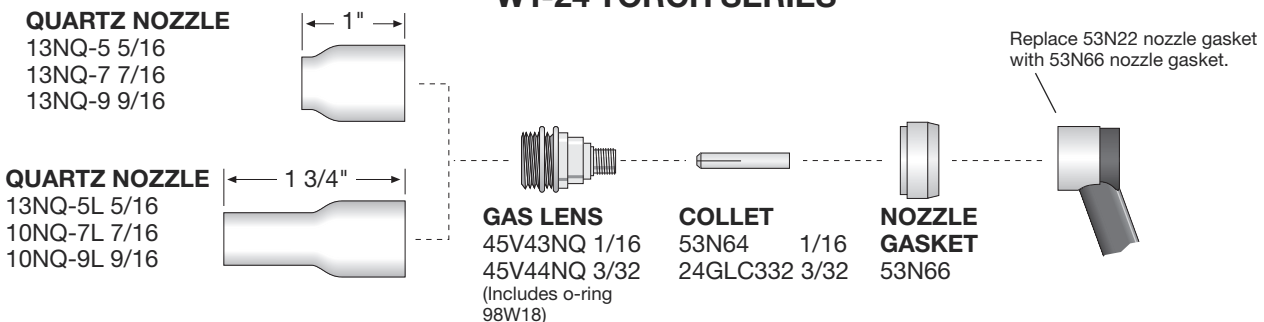

Specifications subject to change without notice.