

CATALOGUE 1.1

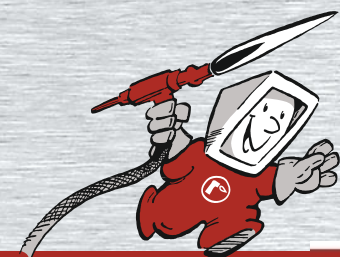

08/2013

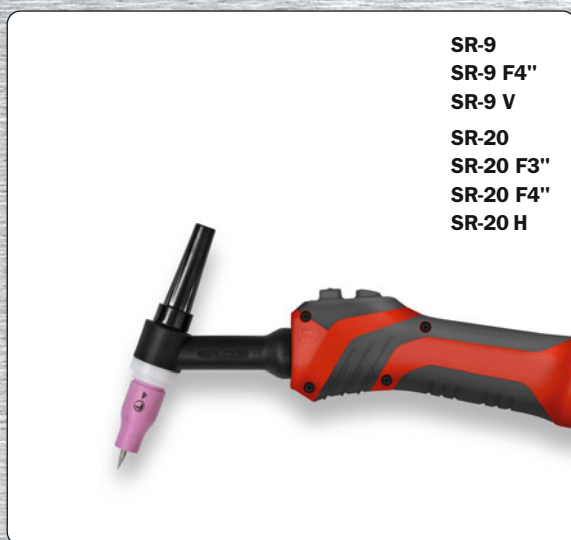

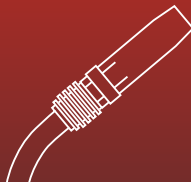
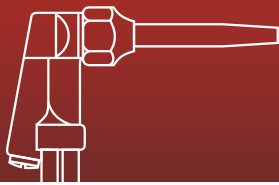

Rohrman Schweisstechnik

Torches and more ...

Partner for welding distributors

Rohrman Schweisstechnik – a family company with more than 40 years of experience in welding technology.

We offer a variety of products for welding such as:

- TIG torches in different styles
- TIG spare parts and accessories
- TIG extension packages
- MIG/MAG torches in different styles
- MIG/MAG spare parts and accessories
- MIG/MAG extension- and interconnection cable packages
- Electrodes-, earth clamps- and cables
- Welding helmets
- Flame cutting torches, hoses and accessories
- Carbon arc gouging torches and accessories

In addition to standard torches we are specialized in **Tungsten Inert Gas** Welding. The wide range of products enables us to provide optimal solutions for different welding applications.

Please ask your welding distributor or feel free to contact us.

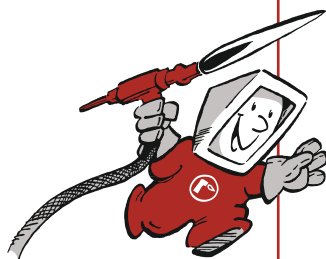

Rohrman Schweisstechnik

Tel.: +49(0)21 62/10 60 65-0

Fax: +49(0)21 62/10 60 65-55

www.rohrman.de · info@rohrman.de

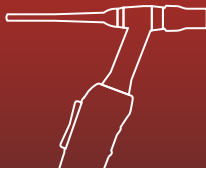
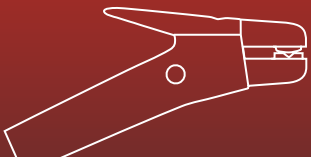

TIG-Torch-Series SR



The TIG-Torch-Series SR is available in the air cooled version with a capacity up to 200 amps and in the water cooled version with a capacity up to 400 amps. The name "SR" stands for "silicone rubber" which is used for the torch body.

TIG torches are applied for welding different metals such as steel, aluminium, magnesium, copper, nickel and titanium.

The TIG welding torches are equipped with the new **RTC-handle – Rohrman TIG Comfort**. The handle has been ergonomically designed and has soft pads for secured grip. Adaptable to the various sizes of torch heads, two handles are available, one small and short for the models SR-9/17/20/24 and one for SR-18/18SC/26. The control functions are optimally arranged thus during welding switching and regulation is possible without lost of control.

The various control elements as there are single/double switch, single switch up/down, double switch up/down and single switch potentiometer must match with the power source.

Rohrman Schweisstechnik supplies the right torch "ready to go" fitting to your welding unit. Our vaste assortment enables special welding solutions.

Please ask your welding distributor or feel free to contact us.



SR-20

SR-24

SR-18

SR-18 SC

Single switch/
Double switch



Single switch
up/down



Single switch
with potentiometer

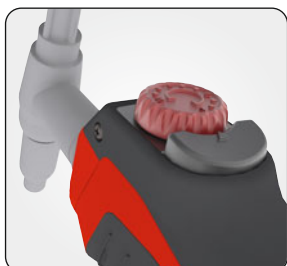

Double switch
up/down



Flex-head TIG torches

Performance Chart TIG-Torch-Series SR

air cooled

Torch	Capacity		Duty cycle ED	Ø Electrode
	DC	AC		
SR-9	120 A	85 A	35 %	0.5–1.6
SR-17	140 A	100 A	35 %	0.5–2.4
SR-24 G	110 A	75 A	35 %	0.5–1.6
SR-26	200 A	140 A	35 %	0.5–3.2

Technical specifications conform to EN 60 974-7 ☺



water cooled

Torch	Capacity		Duty cycle ED	Ø Electrode
	DC	AC		
SR-18	340 A	240 A	100 %	0.5–4.0
SR-18 SC	400 A	280 A	100 %	1.0–4.8
SR-20	240 A	170 A	100 %	0.5–3.2
SR-20 H	270 A	190 A	100 %	0.5–3.2
SR-24 W	180 A	125 A	100 %	0.5–2.4

Technical specifications conform to EN 60 974-7 ☺



Torch packages with basic connection

for SR-9/SR-9 F/SR-9 F4"/SR-17/SR-17 F/SR-24 G/SR-26/SR-26 F:

Torch package with basic connection EB

Power cable gas G1/4", right hand swivel nut with bend protection

Control cable open, 30 cm longer than power cable gas

for SR-9 V/SR-17 V/SR-26 V:

Torch package with basic connection EO

Power cable gas G1/4", right hand swivel nut

for SR-18/SR-18 F/SR-18 SC/SR-20 F/SR-20 F3"/SR-20 F4"/SR-20 H/SR-24 W:

Torch package with basic connection EA

Power cable water M12x1 right hand swivel nut with bend protection

Hose water forward open, 30 cm longer than power cable water

Gas hose open, 30 cm longer than power cable water

Control cable open, 30 cm longer than power cable water

All technical specifications without guarantee

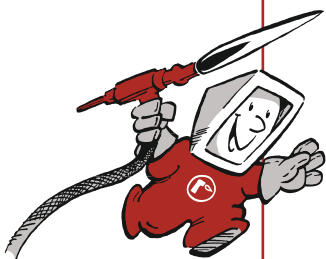

Copyright

All texts, images, graphics and other information published in the catalogue are subject to the copyright of Rohrman Schweißtechnik GmbH unless marked otherwise. Any reprinting, even in extracts, are only permitted with the prior written permission of Rohrman Schweißtechnik GmbH.



ROHRMAN
SCHWEISSTECHNIK



Spare Parts SR-9/20



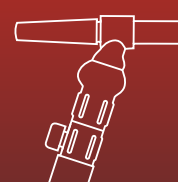
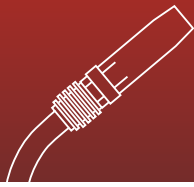
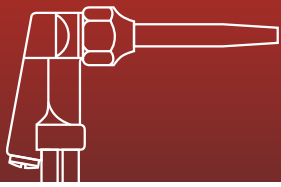

Spare Parts SR-9/SR-20

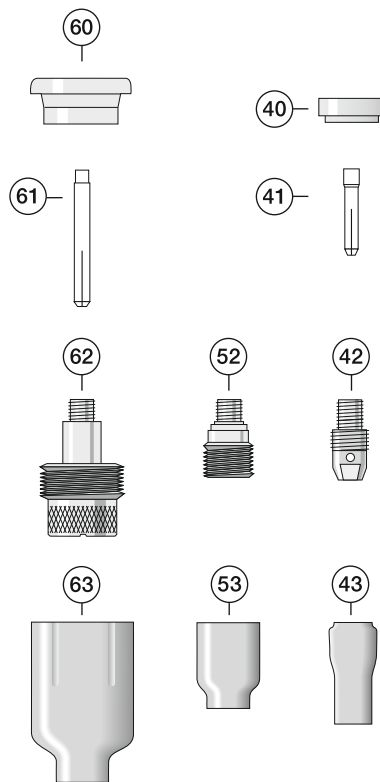
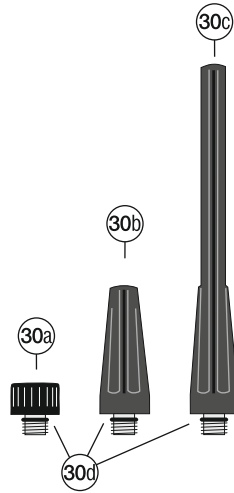

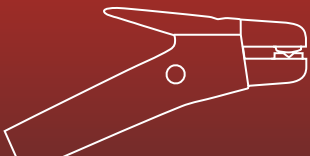
**Spare Parts SR-9/20**

Position	Article Description	Order Number
30a	Back Cap Short L=19 mm [5/8"]	85741330
30b	Back Cap Medium L=50 mm [2"] [1 7/8"]	85741350
30c	Back Cap Long L=145 mm [5 5/8"]	85741240
30d	O-Ring Red	8550904520R
40	Insulator	85504820
41	Collet Ø 0.5 mm [.020"] L=25 mm [1"]	85113200
	Collet Ø 1.0 mm [.040"] L=25 mm [1"]	85113210
	Collet Ø 1.6 mm [1/16"] L=25 mm [1"]	85113220
	Collet Ø 2.4 mm [3/32"] L=25 mm [1"]	85113230
	Collet Ø 3.2 mm [1/8"] L=25 mm [1"]	85113240
42	Collet Body Ø 0.5 mm [.020"] L=21 mm [13/16"]	85123250
	Collet Body Ø 1.0 mm [.040"] L=21 mm [13/16"]	85123260
	Collet Body Ø 1.6 mm [1/16"] L=21 mm [13/16"]	85123270
	Collet Body Ø 2.4 mm [3/32"] L=21 mm [13/16"]	85123280
	Collet Body Ø 3.2 mm [1/8"] L=21 mm [13/16"]	85123290
43	Gas Nozzle Size 4 Ø 6.4 mm [1/4"] L=30 mm [1 1/8"]	85213080
	Gas Nozzle Size 5 Ø 8.0 mm [5/16"] L=30 mm [1 1/8"]	85213090
	Gas Nozzle Size 6 Ø 9.6 mm [3/8"] L=30 mm [1 1/8"]	85213100
	Gas Nozzle Size 7 Ø 11.2 mm [7/16"] L=30 mm [1 1/8"]	85213110
	Gas Nozzle Size 8 Ø 12.8 mm [1/2"] L=30 mm [1 1/8"]	85213120
	Gas Nozzle Size 10 Ø 16.0 mm [5/8"] L=30 mm [1 1/8"]	85213130
52	Gas Lens Standard Ø 0.5 mm [.020"] L=22 mm [7/8"]	85134541
	Gas Lens Standard Ø 1.0 mm [.040"] L=22 mm [7/8"]	85134542
	Gas Lens Standard Ø 1.6 mm [1/16"] L=22 mm [7/8"]	85134543
	Gas Lens Standard Ø 2.4 mm [3/32"] L=22 mm [7/8"]	85134544
	Gas Lens Standard Ø 3.2 mm [1/8"] L=22 mm [7/8"]	85134545
53	Gas Nozzle Size 4 Ø 6.4 mm [1/4"] L=25 mm [1"]	85253580
	Gas Nozzle Size 5 Ø 8.0 mm [5/16"] L=25 mm [1"]	85253590
	Gas Nozzle Size 6 Ø 9.6 mm [3/8"] L=25 mm [1"]	85253600
	Gas Nozzle Size 7 Ø 11.2 mm [7/16"] L=25 mm [1"]	85253610
	Gas Nozzle Size 8 Ø 12.8 mm [1/2"] L=25 mm [1"]	85253612
60	Insulator Adapter Gas Lens Jumbo	85504632
61	Collet Jumbo Ø 0.5 mm [.020"] L=40 mm [1 9/16"]	85113204
	Collet Jumbo Ø 1.0 mm [.040"] L=40 mm [1 9/16"]	85113214
	Collet Jumbo Ø 1.6 mm [1/16"] L=40 mm [1 9/16"]	85113224
	Collet Jumbo Ø 2.4 mm [3/32"] L=40 mm [1 9/16"]	85113234
	Collet Jumbo Ø 3.2 mm [1/8"] L=40 mm [1 9/16"]	85113244
62	Gas Lens Jumbo Ø 0.5 – 1.0 mm [0.20" – .040"] L=41 mm [1 5/8"]	85136504
	Gas Lens Jumbo Ø 1.6 mm [1/16"] L=41 mm [1 5/8"]	85136516
	Gas Lens Jumbo Ø 2.4 mm [3/32"] L=41 mm [1 5/8"]	85136564
	Gas Lens Jumbo Ø 3.2 mm [1/8"] L=41 mm [1 5/8"]	85136795
63	Gas Nozzle Jumbo Size 6 Ø 9.6 mm [3/8"] L=48 mm [1 7/8"]	85257750
	Gas Nozzle Jumbo Size 8 Ø 12.8 mm [1/2"] L=48 mm [1 7/8"]	85257740
	Gas Nozzle Jumbo Size 10 Ø 16.0 mm [5/8"] L=48 mm [1 7/8"]	85253880
	Gas Nozzle Jumbo Size 12 Ø 19.6 mm [3/4"] L=48 mm [1 7/8"]	85253870

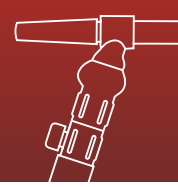
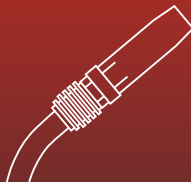
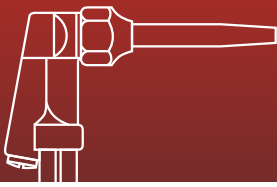

Accessory Set SR-9/20 consists of:

**1x Back Cap Long, 1x Collet, 1x Collet Body, 1x Gas Nozzle
(packed in a transparent bag)**

Position	Article Description	Order Number
	Accessory Set Ø 0.5 mm [.020"]	855220200-05
	Accessory Set Ø 1.0 mm [.040"]	855220200-10
	Accessory Set Ø 1.6 mm [1/16"]	855220200-16
	Accessory Set Ø 2.4 mm [3/32"]	855220200-24
	Accessory Set Ø 3.2 mm [1/8"]	855220200-32

Accessory Box SR-9/20 consists of:

**1x Insulator, 1x Back Cap Short /Medium /Long,
2x Collet, 2x Collet Body, 2x Gas Nozzle,
2x Gas Lens, 2x Gas Nozzle (Gas Lens)
(packed in a plastic box)**

Position	Article Description	Order Number
	Accessory Box Ø 0.5 mm [.020"]	855220200-B05
	Accessory Box Ø 1.0 mm [.040"]	855220200-B10
	Accessory Box Ø 1.6 mm [1/16"]	855220200-B16
	Accessory Box Ø 2.4 mm [3/32"]	855220200-B24
	Accessory Box Ø 3.2 mm [1/8"]	855220200-B32

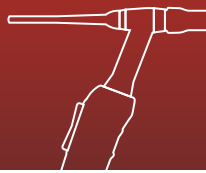

ROHRMAN
SCHWEISSTECHNIK



Spare Parts SR-17/18/26



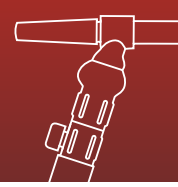
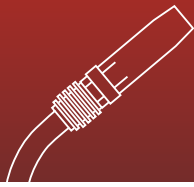
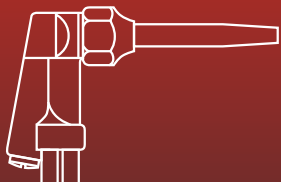

Spare Parts SR-17/18/26

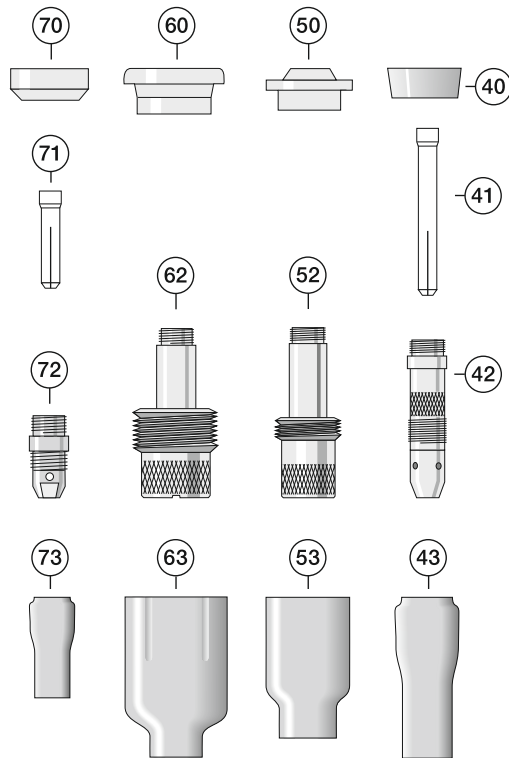
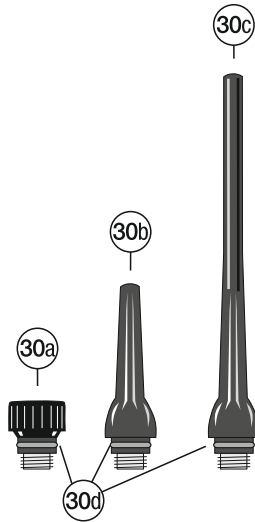

**Spare Parts SR-17/18/26**

Position	Article Description	Order Number
30a	Back Cap Short L=25 mm [1"]	85757040
30b	Back Cap Medium L=60 mm [2.35"]	85757030
30c	Back Cap Long L=120 mm [4 3/4"]	85757020
30d	O-Ring Red for Back Cap	8550908017R
40	Insulator Standard	85504181
41	Collet Ø 0.5 mm [.020"] L=50 mm [2"]	85110210
	Collet Ø 1.0 mm [.040"] L=50 mm [2"]	85110220
	Collet Ø 1.6 mm [1/16"] L=50 mm [2"]	85110230
	Collet Ø 2.4 mm [3/32"] L=50 mm [2"]	85110240
	Collet Ø 3.2 mm [1/8"] L=50 mm [2"]	85110250
	Collet Ø 4.0 mm [5/32"] L=50 mm [2"]	85114200
42	Collet Body Ø 0.5 mm [.020"] L=47 mm [1 7/8"]	85120290
	Collet Body Ø 1.0 mm [.040"] L=47 mm [1 7/8"]	85120300
	Collet Body Ø 1.6 mm [1/16"] L=47 mm [1 7/8"]	85120310
	Collet Body Ø 2.4 mm [3/32"] L=47 mm [1 7/8"]	85120320
	Collet Body Ø 3.2 mm [1/8"] L=47 mm [1 7/8"]	85120280
	Collet Body Ø 4.0 mm [5/32"] L=47 mm [1 7/8"]	85124880
43	Gas Nozzle Size 4 Ø 6.4 mm [1/4"] L=47 mm [1 7/8"]	85210500
	Gas Nozzle Size 5 Ø 8.0 mm [5/16"] L=47 mm [1 7/8"]	85210490
	Gas Nozzle Size 6 Ø 9.6 mm [3/8"] L=47 mm [1 7/8"]	85210480
	Gas Nozzle Size 7 Ø 11.2 mm [7/16"] L=47 mm [1 7/8"]	85210470
	Gas Nozzle Size 8 Ø 12.8 mm [1/2"] L=47 mm [1 7/8"]	85210460
	Gas Nozzle Size 10 Ø 16.0 mm [5/8"] L=47 mm [1 7/8"]	85210450
	Gas Nozzle Size 12 Ø 19.2 mm [3/4"] L=47 mm [1 7/8"]	85210440
50	Insulator Adapter Gas Lens Standard	85504010
52	Gas Lens Standard Ø 0.5 mm [.020"] L=50 mm [2"]	85134529
	Gas Lens Standard Ø 1.0 mm [.040"] L=50 mm [2"]	85134524
	Gas Lens Standard Ø 1.6 mm [1/16"] L=50 mm [2"]	85134525
	Gas Lens Standard Ø 2.4 mm [3/32"] L=50 mm [2"]	85134526
	Gas Lens Standard Ø 3.2 mm [1/8"] L=50 mm [2"]	85134527
	Gas Lens Standard Ø 4.0 mm [5/32"] L=50 mm [2"]	85134528
53	Gas Nozzle Size 4 Ø 6.4 mm [1/4"] L=42 mm [1 5/8"]	85254180
	Gas Nozzle Size 5 Ø 8.0 mm [5/16"] L=42 mm [1 5/8"]	85254170
	Gas Nozzle Size 6 Ø 9.6 mm [3/8"] L=42 mm [1 5/8"]	85254160
	Gas Nozzle Size 7 Ø 11.2 mm [7/16"] L=42 mm [1 5/8"]	85254150
	Gas Nozzle Size 8 Ø 12.8 mm [1/2"] L=42 mm [1 5/8"]	85254140
	Gas Nozzle Size 10 Ø 16.0 mm [5/8"] L=42 mm [1 5/8"]	85254120
	Gas Nozzle Size 12 Ø 19.2 mm [3/4"] L=42 mm [1 5/8"]	85254100
60	Insulator Jumbo	85504630
62	Gas Lens Jumbo Ø 0.5–1.0 mm [.020" – 0.040"] L=50 mm [2"]	85134502
	Gas Lens Jumbo Ø 1.6 mm [1/16"] L=50 mm [2"]	85134516
	Gas Lens Jumbo Ø 2.4 mm [3/32"] L=50 mm [2"]	85134564
	Gas Lens Jumbo Ø 3.2 mm [1/8"] L=50 mm [2"]	85135795
	Gas Nozzle Jumbo Ø 4.0 mm [5/32"] L=50 mm [2"]	85134563
63	Gas Nozzle Jumbo Size 6 Ø 9.6 mm [3/8"] L=48 mm [1 7/8"]	85257750
	Gas Nozzle Jumbo Size 8 Ø 12.8 mm [1/2"] L=48 mm [1 7/8"]	85257740
	Gas Nozzle Jumbo Size 10 Ø 16.0 mm [5/8"] L=48 mm [1 7/8"]	85253880
	Gas Nozzle Jumbo Size 12 Ø 19.2 mm [3/4"] L=48 mm [1 7/8"]	85253870

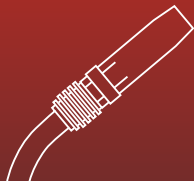
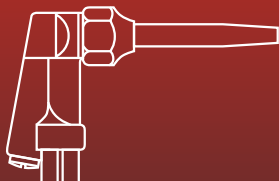

Spare Parts SR-17/18/26

Position	Article Description	Order Number
70	Insulator Stubby	85504182
71	Collet Stubby Ø 1.6 mm [1/16"] L=29,5 mm [1 1/8"]	85110231
	Collet Stubby Ø 2.4 mm [3/32"] L=29,5 mm [1 1/8"]	85110241
	Collet Stubby Ø 3.2 mm [1/8"] L=29,5 mm [1 1/8"]	85110251
72	Collet Body Stubby Ø 1.6–3.2 mm [1/16"–1/8"]	85122000
73	Gas Nozzle Size 4 Ø 6.4 mm [1/4"] L=30 mm [1 1/8"]	85213080
	Gas Nozzle Size 5 Ø 8.0 mm [5/16"] L=30 mm [1 1/8"]	85213090
	Gas Nozzle Size 6 Ø 9.6 mm [3/8"] L=30 mm [1 1/8"]	85213100
	Gas Nozzle Size 7 Ø 11.2 mm [7/16"] L=30 mm [1 1/8"]	85213110
	Gas Nozzle Size 8 Ø 12.8 mm [1/2"] L=30 mm [1 1/8"]	85213120
	Gas Nozzle Size 10 Ø 16.0 mm [5/8"] L=30 mm [1 1/8"]	85213130
	Collet Ø 1.6 mm [1/16"] L=33 mm [1.3"]	85110230GB
	Collet Ø 2.4 mm [3/32"] L=33 mm [1.3"]	85110240GB
	Collet Ø 3.2 mm [1/8"] L=33 mm [1.3"]	85110250GB
	Gas Lens Stubby Ø 1.6 mm [1/16"]	85134551
	Gas Lens Stubby Ø 2.4 mm [3/32"]	85134552
	Gas Lens Stubby Ø 3.2 mm [1/8"]	85134553
	Gas Nozzle Size 4 Ø 6.4 mm [1/4"] L=25 mm [1"]	85253580
	Gas Nozzle Size 5 Ø 8.0 mm [5/16"] L=25 mm [1"]	85253590
	Gas Nozzle Size 6 Ø 9.6 mm [3/8"] L=25 mm [1"]	85253600
	Gas Nozzle Size 7 Ø 11.2 mm [7/16"] L=25 mm [1"]	84253610
	Gas Nozzle Size 8 Ø 12.8 mm [1/2"] L=25 mm [1"]	84253612

Accessory Set SR-17/18/26 consists of:

1x Back Cap Long, 1x Collet, 1x Collet Body, 1x Gas Nozzle
(packed in a transparent bag)

Position	Article Description	Order Number
	Accessory Set Ø 1.0 mm [.040"]	855220170-10
	Accessory Set Ø 1.6 mm [1/16"]	855220170-16
	Accessory Set Ø 2.4 mm [3/32"]	855220170-24
	Accessory Set Ø 3.2 mm [1/8"]	855220170-32
	Accessory Set Ø 4.0 mm [5/32"]	855220170-40

Accessory Box SR-17/18/26 consists of:

1x Insulator, 1x Back Cap Short /Medium /Long,
2x Collet, 2x Collet Body, 2x Gas Nozzle,
1x Insulator-Adapter (Gas Lens), 2x Gas Lens, 2x Gas Nozzle (Gas Lens)
(packed in a plastic box)

Position	Article Description	Order Number
	Accessory Box Ø 1.0 mm [.040"]	855220170-B10
	Accessory Box Ø 1.6 mm [1/16"]	855220170-B16
	Accessory Box Ø 2.4 mm [3/32"]	855220170-B24
	Accessory Box Ø 3.2 mm [1/8"]	855220170-B32
	Accessory Box Ø 4.0 mm [5/32"]	855220170-B40



Spare Parts SR-18 SC



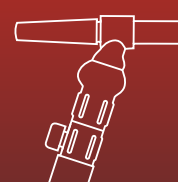
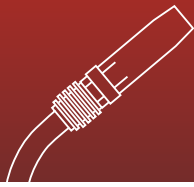
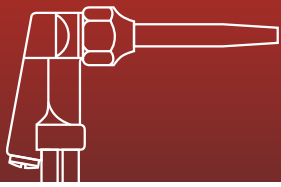

Spare Parts SR-18 SC

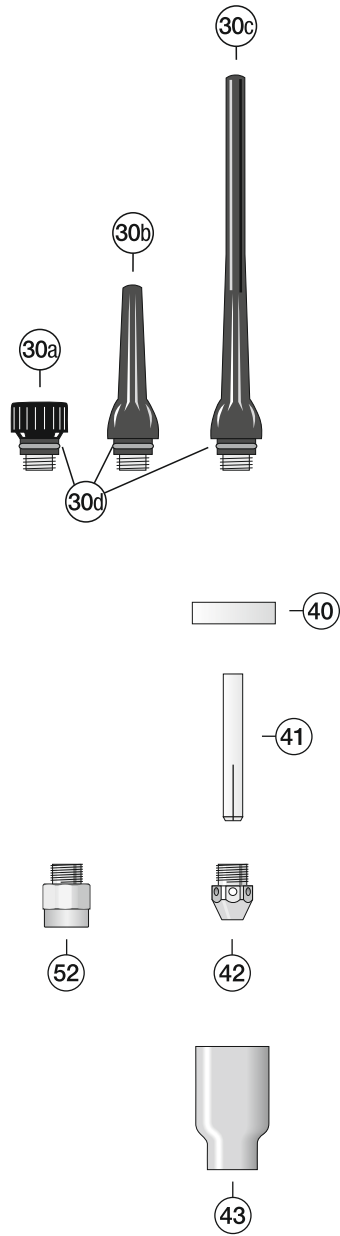

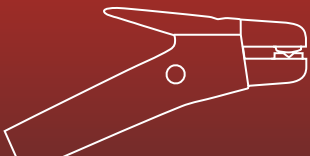
**Spare Parts SR-18 SC**

Position	Article Description	Order Number
30a	Back Cap Short L=25 mm [1"]	85757040
30b	Back Cap Medium L=60 mm [2.35"]	85757030
30c	Back Cap Long L=120 mm [4 3/4"]	85757020
30d	O-Ring	8550908017R
40	Insulator	85504186
41	Collet Ø 1.0 mm [.040"] L=49 mm [1 15/16"]	85110220HD
	Collet Ø 1.6 mm [1/16"] L=49 mm [1 15/16"]	85110230HD
	Collet Ø 2.4 mm [3/32"] L=49 mm [1 15/16"]	85110240HD
	Collet Ø 3.2 mm [1/8"] L=49 mm [1 15/16"]	85110250HD
	Collet Ø 4.0 mm [5/32"] L=49 mm [1 15/16"]	85114200HD
	Collet Ø 4.8 mm [3/16"] L=49 mm [1 15/16"]	85118360HD
42	Collet Body Ø 1.0–3.2 mm [.040" – 1/8"] L=29.5 mm [1 1/8"]	85120530
	Collet Body Ø 3.2–4.8 mm [1/8" – 3/16"] L=29.5 mm [1 1/8"]	85120360
52	Gas Lens Standard Ø 1.0 mm [.040"] L=21 mm [7/8"]	85131804
	Gas Lens Standard Ø 1.6 mm [1/16"] L=21 mm [7/8"]	85131806
	Gas Lens Standard Ø 2.4 mm [3/32"] L=21 mm [7/8"]	85131832
	Gas Lens Standard Ø 3.2 mm [1/8"] L=21 mm [7/8"]	85131818
	Gas Lens Standard Ø 4.0 mm [5/32"] L=21 mm [7/8"]	85131853
	Gas Lens Standard Ø 4.8 mm [3/16"] L=21 mm [7/8"]	85131836
43	Gas Nozzle Size 4 Ø 6.4 mm [1/4"] L=42 mm [1 5/8"]	85254180
	Gas Nozzle Size 5 Ø 8.0 mm [5/16"] L=42 mm [1 5/8"]	85254170
	Gas Nozzle Size 6 Ø 9.6 mm [3/8"] L=42 mm [1 5/8"]	85254160
	Gas Nozzle Size 7 Ø 11.2 mm [7/16"] L=42 mm [1 5/8"]	85254150
	Gas Nozzle Size 8 Ø 12.8 mm [1/2"] L=42 mm [1 5/8"]	85254140
	Gas Nozzle Size 10 Ø 16.0 mm [5/8"] L=42 mm [1 5/8"]	85254120
	Gas Nozzle Size 12 Ø 19.2 mm [3/4"] L=42 mm [1 5/8"]	85254100

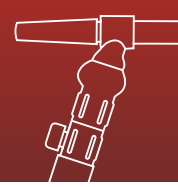
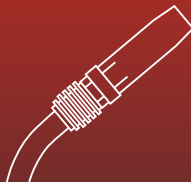
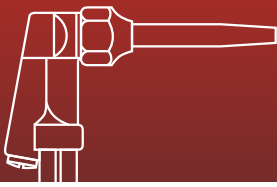

Accessory Set SR-18 SC consists of:

**1x Back Cap Long, 1x Collet, 1x Collet Body, 1x Gas Nozzle
(packed in a transparent bag)**

Position	Article Description	Order Number
	Accessory Set Ø 1.0 mm [.040"]	85522018C-10
	Accessory Set Ø 1.6 mm [1/16"]	85522018C-16
	Accessory Set Ø 2.4 mm [3/32"]	85522018C-24
	Accessory Set Ø 3.2 mm [1/8"]	85522018C-32
	Accessory Set Ø 4.0 mm [5/32"]	85522018C-40
	Accessory Set Ø 4.8 mm [3/16"]	85522018C-48

Accessory Box SR-18 SC consists of:

**1x Insulator, 1x Back Cap Short /Medium /Long,
2x Collet, 2x Collet Body, 2x Gas Nozzle,
2x Gas Lens, 2x Gas Nozzle (Gas Lens)
(packed in a plastic box)**

Position	Article Description	Order Number
	Accessory Box Ø 1.0 mm [.040"]	85522018C-B10
	Accessory Box Ø 1.6 mm [1/16"]	85522018C-B16
	Accessory Box Ø 2.4 mm [3/32"]	85522018C-B24
	Accessory Box Ø 3.2 mm [1/8"]	85522018C-B32
	Accessory Box Ø 4.0 mm [5/32"]	85522018C-B40
	Accessory Box Ø 4.8 mm [3/16"]	85522018C-B48

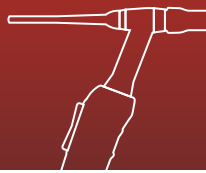

Spare Parts SR-24

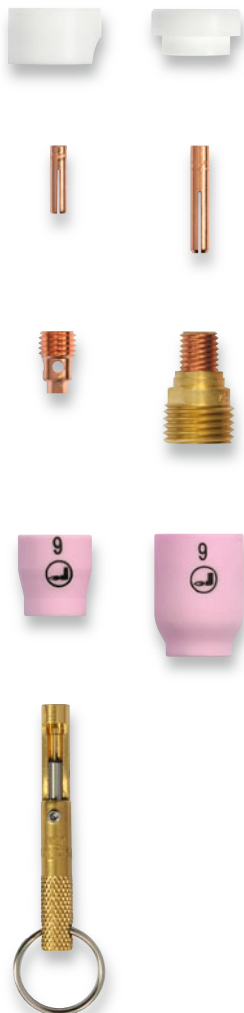

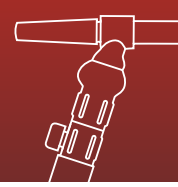
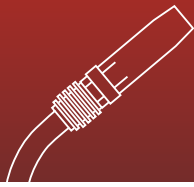
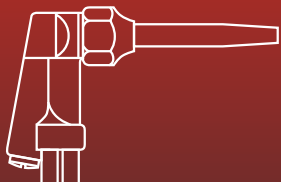

Spare Parts SR-24

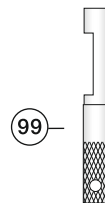
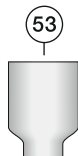



Spare Parts SR-24

Position	Article Description	Order Number
40	Insulator	85504222
41	Collet Ø 0.5 mm [.020"] L=14 mm [0.56"]	85113150
	Collet Ø 1.0 mm [.040"] L=14 mm [0.56"]	85113160
	Collet Ø 1.6 mm [1/16"] L=14 mm [0.56"]	85113140
	Collet Ø 2.4 mm [3/32"] L=14 mm [0.56"]	85113320
42	Collet Body Ø 0.5 mm [.020"]	85123170
	Collet Body Ø 1.0 mm [.040"]	85123180
	Collet Body Ø 1.6 mm [1/16"]	85123190
	Collet Body Ø 2.4 mm [3/32"]	85123320
43a	Gas Nozzle Size 4 Ø 6.4 mm [1/4"] L=16.5 mm [0.66"]	85253240
	Gas Nozzle Size 5 Ø 8.0 mm [5/16"] L=16.5 mm [0.66"]	85253250
	Gas Nozzle Size 6 Ø 9.6 mm [3/8"] L=16.5 mm [0.66"]	85253270
43b	Gas Nozzle Size 4 Ø 6.4 mm [1/4"] L=29 mm [1 1/8"]	85253280
	Gas Nozzle Size 6 Ø 9.6 mm [3/8"] L=29 mm [1 1/8"]	85253260
50	Insulator for Gas Lens	85504660
51	Collet Ø 0.5 mm [.020"] L=23 mm [0.92"]	85113620
	Collet Ø 1.0 mm [.040"] L=23 mm [0.92"]	85113630
	Collet Ø 1.6 mm [1/16"] L=23 mm [0.92"]	85113640
	Collet Ø 2.4 mm [3/32"] L=23 mm [0.92"]	85113323
52	Gas Lens Ø 0.5 mm [.020"]	85134541
	Gas Lens Ø 1.0 mm [.040"]	85134542
	Gas Lens Ø 1.6 mm [1/16"]	85134543
	Gas Lens Ø 2.4 mm [3/32"]	85134544
53	Gas Nozzle Size 4 Ø 6.4 mm [1/4"] L=25 mm [1"]	85253580
	Gas Nozzle Size 5 Ø 8.0 mm [5/16"] L=25 mm [1"]	85253590
	Gas Nozzle Size 6 Ø 9.6 mm [3/8"] L=25 mm [1"]	85253600
	Gas Nozzle Size 7 Ø 11.2 mm [7/16"] L=25 mm [1"]	85253610
	Gas Nozzle Size 8 Ø 12.8 mm [1/2"] L=25 mm [1"]	85253612
99	Wrench	85521002

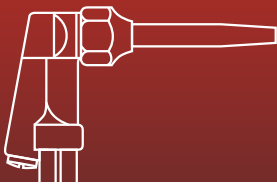

Accessory Set SR-24 consists of:

1x Collet, 1x Collet Body, 1x Gas Nozzle
(packed in a transparent bag)

Position	Article Description	Order Number
	Accessory Set Ø 0.5 mm [.020"]	85522024G-05
	Accessory Set Ø 1.0 mm [.040"]	85522024G-10
	Accessory Set Ø 1.6 mm [1/16"]	85522024G-16
	Accessory Set Ø 2.4 mm [3/32"]	85522024G-24

Accessory Box SR-24 consists of:

1x Spanschlüssel, 1x Insulator, 2x Collet,
2x Collet Body, 2x Gas Nozzle, 1x Insulator (Gas Lens),
2x Collet (Gas Lens), 2x Gas Lens, 2x Gas Nozzle (Gas Lens)
(packed in a plastic box)

Position	Article Description	Order Number
	Accessory Box Ø 0.5 mm [.020"]	85522024G-B05
	Accessory Box Ø 1.0 mm [.040"]	85522024G-B10
	Accessory Box Ø 1.6 mm [1/16"]	85522024G-B16
	Accessory Box Ø 2.4 mm [3/32"]	85522024G-B24

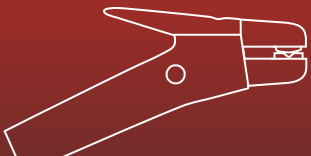

ROHRMAN
SCHWEISSTECHNIK



SR-9



SR-9 F4"



SR-9 V



TIG-Torches SR-9, SR-9 F4", SR-9 V

Capacity at 35% duty cycle (10 min. cycle)	Type of cooling	Electrode diameter	Standard	Connection
Direct current (DC) 120 A Alternating current (AC) 85 A	Air cooled	0.5–1.6 mm	Conform to EN 60974-7 CE	Suitable for any power supply in the market

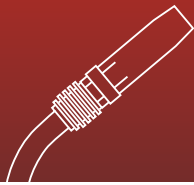
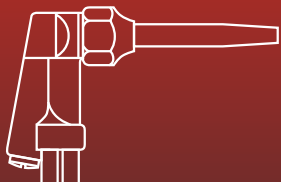

SR-9/SR-9 F

120 A – DC – 35% Duty Cycle
85 A – AC – 35% Duty Cycle

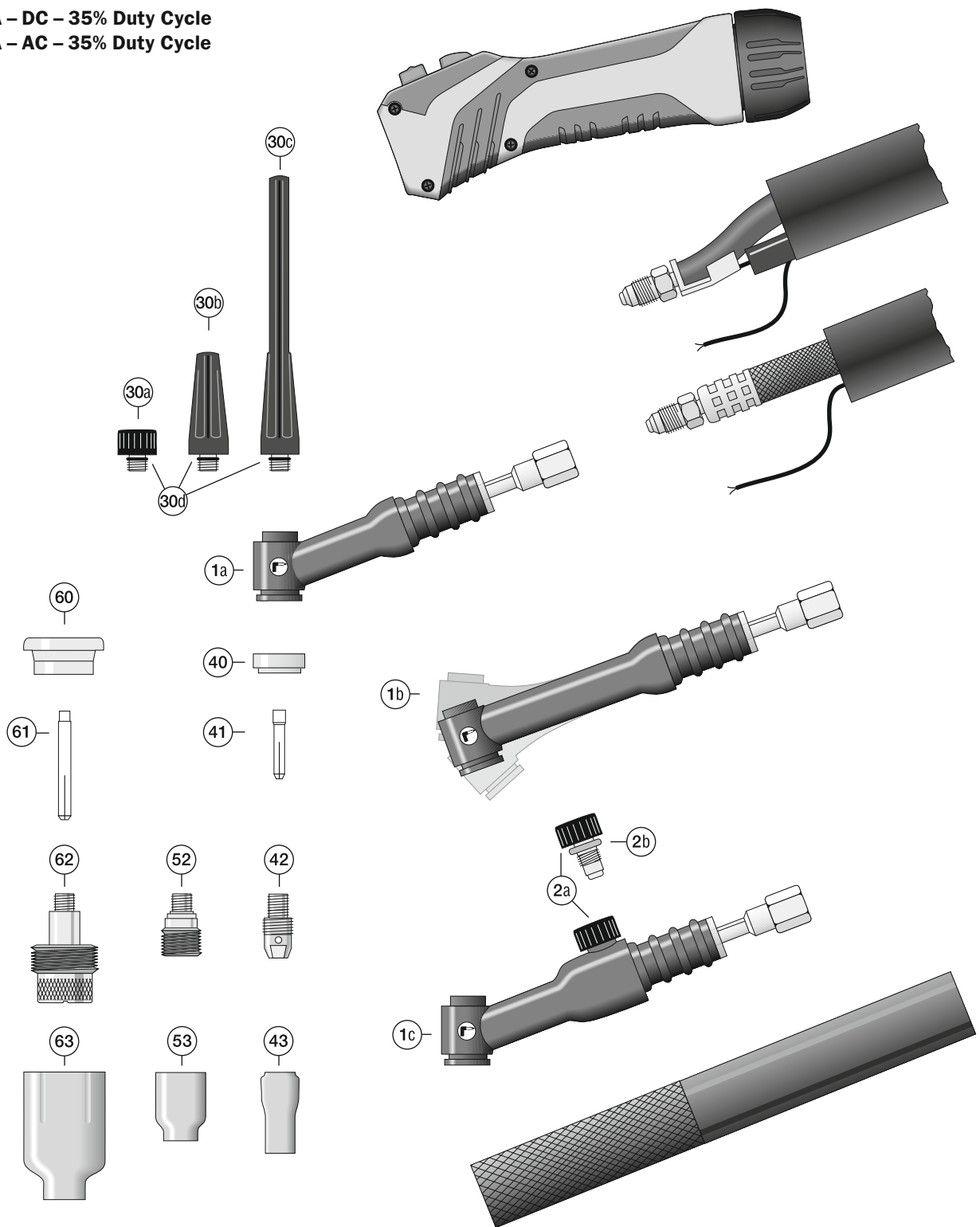

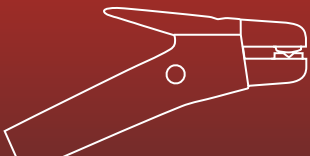

TIG Torches SR-9 with Highflex (HF) Torch Package and Basic Connection

Position	Article Description	Order Number
	SR-9/4 m, Leather+Rubber, G-Cu-W, RTC-DD	84B1009004EB01D
	SR-9/8 m, Leather+Rubber, G-Cu-W, RTC-DD	84B1009008EB01D

TIG Torches SR-9 F with Highflex (HF) Torch Package and Basic Connection

Position	Article Description	Order Number
	SR-9 F/4 m, Leather+Rubber, G-Cu-W, RTC-DD	84B1009204EB01D
	SR-9 F/8 m, Leather+Rubber, G-Cu-W, RTC-DD	84B1009208EB01D

TIG Torches SR-9 F4" with Highflex (HF) Torch Package and Basic Connection

Position	Article Description	Order Number
	SR-9 F4"/4 m, Leather+Rubber, G-Cu-W, RTC-DD	84B1009404EB01D
	SR-9 F4"/8 m, Leather+Rubber, G-Cu-W, RTC-DD	84B1009408EB01D

TIG Torches SR-9 V with Power-/ Gas- Cable and Basic Connection

Position	Article Description	Order Number
	SR-9 V/4 m, T-Cu, Handle Round	8407009V04E030
	SR-9 V/8 m, T-Cu, Handle Round	8407009V08E030

TIG Torches SR-9 FV with Power-/ Gas- Cable and Basic Connection

Position	Article Description	Order Number
	SR-9 FV/4 m, T-Cu, Handle Round	8407009Y04E030
	SR-9 FV/8 m, T-Cu, Handle Round	8407009Y08E030

Replacement Parts Torch Body

Position	Article Description	Order Number
1a	Torch Body SR-9	85600090
	Torch Body SR-9F with Flexible Torch Body	85600092
1b	Torch Body SR-9F4" (100 mm) with Flexible Torch Body	85600094
1c	Torch Body SR-9V with Valve Knob	8560009V
	Torch Body SR-9FV with Flexible Torch Body and Valve Knob	8560009Y
2a	Valve Knob for SR-9V	85511002
2b	O-Ring Valve Knob	8550904520R

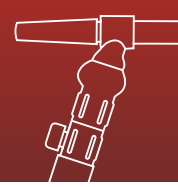
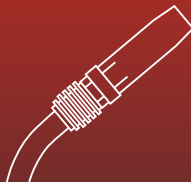
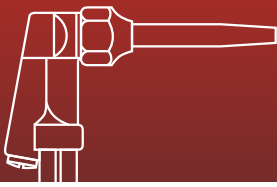

TIG Torches SR-9 with Highflex-Canvas (HFG) Torch Package and Basic Connection

Position	Article Description	Order Number
	SR-9/ 4 m, Leather+Canvas, G-Cu-W, RTC-DD	84F1009004EB01D
	SR-9/ 8 m, Leather+Canvas, G-Cu-W, RTC-DD	84F1009008EB01D
	SR-9/12 m, Leather+Canvas, G-Cu-W, RTC-DD	84F1009012EB01D
	SR-9/16 m, Leather+Canvas, G-Cu-W, RTC-DD	84F1009016EB01D

TIG Torches SR-9 F with Highflex-Canvas (HFG) Torch Package and Basic Connection

Position	Article Description	Order Number
	SR-9 F/ 4 m, Leather+Canvas, G-Cu-W, RTC-DD	84F1009204EB01D
	SR-9 F/ 8 m, Leather+Canvas, G-Cu-W, RTC-DD	84F1009208EB01D
	SR-9 F/12 m, Leather+Canvas, G-Cu-W, RTC-DD	84F1009212EB01D
	SR-9 F/16 m, Leather+Canvas, G-Cu-W, RTC-DD	84F1009216EB01D

TIG Torches SR-9 F4" with Highflex-Canvas (HFG) Torch Package and Basic Connection

Position	Article Description	Order Number
	SR-9 F4"/ 4 m, Leather+Canvas, G-Cu-W, RTC-DD	84F1009404EB01D
	SR-9 F4"/ 8 m, Leather+Canvas, G-Cu-W, RTC-DD	84F1009408EB01D
	SR-9 F4"/12 m, Leather+Canvas, G-Cu-W, RTC-DD	84F1009404EB01D
	SR-9 F4"/16 m, Leather+Canvas, G-Cu-W, RTC-DD	84F1009408EB01D

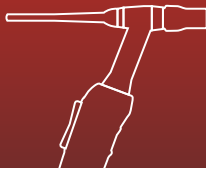
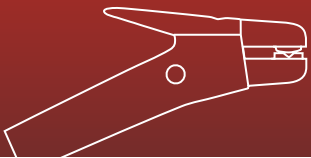

ROHRMAN
SCHWEISSTECHNIK



SR-17



SR-17 V

TIG-Torches SR-17, SR-17 V

Capacity at 35% duty cycle (10 min. cycle)	Type of cooling	Electrode diameter	Standard	Connection
Direct current (DC) 140 A Alternating current (AC) 100 A	Air cooled	0.5–2.4 mm	Conform to EN 60974-7 CE	Suitable for any power supply in the market

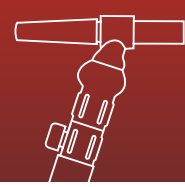
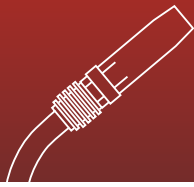
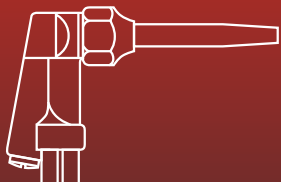

SR-17/F/V

140 A – DC – 35% Duty Cycle
100 A – AC – 35% Duty Cycle

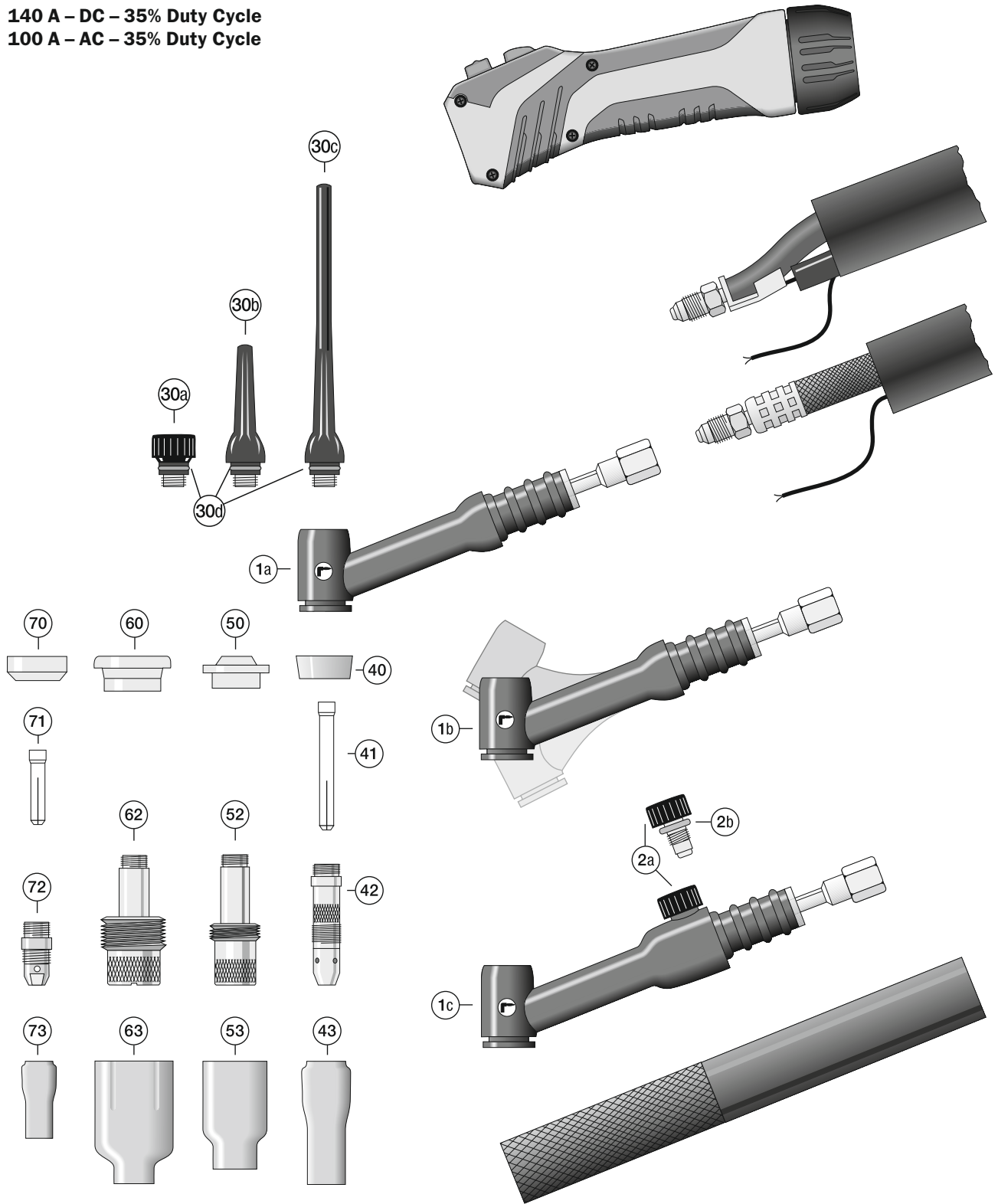



TIG Torches SR-17 with Highflex (HF) Torch Package and Basic Connection

Position	Article Description	Order Number
	SR-17/4 m, Leather+Rubber, G-Cu-W, RTC-DD	84B1017004EB01D
	SR-17/8 m, Leather+Rubber, G-Cu-W, RTC-DD	84B1017008EB01D

TIG Torches SR-17 F with Highflex (HF) Torch Package and Basic Connection

Position	Article Description	Order Number
	SR-17 F/4 m, Leather+Rubber, G-Cu-W, RTC-DD	84B1017204EB01D
	SR-17 F/8 m, Leather+Rubber, G-Cu-W, RTC-DD	84B1017208EB01D

TIG Torches SR-17 V with Power-/ Gas- Cable and Basic Connection

Position	Article Description	Order Number
	SR-17 V/4 m, T-Cu, Handle Round	8407017V04E030
	SR-17 V/8 m, T-Cu, Handle Round	8407017V08E030

TIG Torches SR-17 FV with Power-/ Gas- Cable and Basic Connection

Position	Article Description	Order Number
	SR-17 FV/4 m, T-Cu, Handle Round	8407017Y04E030
	SR-17 FV/8 m, T-Cu, Handle Round	8407017Y08E030

Replacement Parts Torch Body

Position	Article Description	Order Number
1a	Torch Body SR-17	85600170
1b	Torch Body SR-17 F with Flexible Torch Body	85600172
1c	Torch Body SR-17 V with Valve Knob	8560017V
	Torch Body SR-17 FV with Flexible Torch Body and Valve Knob	8560017Y
2a	Valve Knob SR-17 V	85511002
2b	O-Ring	8550904520R

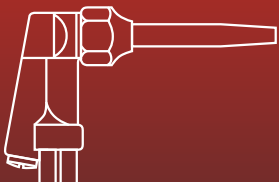

TIG Torches SR-17 with Highflex-Canvas (HFG) Torch Package and Basic Connection

Position	Article Description	Order Number
	SR-17/ 4 m, Leather+Canvas, G-Cu-W, RTC-DD	84F1017004EB01D
	SR-17/ 8 m, Leather+Canvas, G-Cu-W, RTC-DD	84F1017008EB01D
	SR-17/12 m, Leather+Canvas, G-Cu-W, RTC-DD	84F1017012EB01D
	SR-17/16 m, Leather+Canvas, G-Cu-W, RTC-DD	84F1017016EB01D

TIG Torches SR-17 F with Highflex-Canvas (HFG) Torch Package and Basic Connection

Position	Article Description	Order Number
	SR-17 F/ 4 m, Leather+Canvas, G-Cu-W, RTC-DD	84F1017204EB01D
	SR-17 F/ 8 m, Leather+Canvas, G-Cu-W, RTC-DD	84F1017208EB01D
	SR-17 F/12 m, Leather+Canvas, G-Cu-W, RTC-DD	84F1017212EB01D
	SR-17 F/16 m, Leather+Canvas, G-Cu-W, RTC-DD	84F1017216EB01D

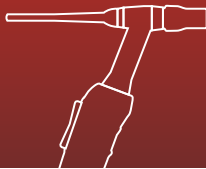
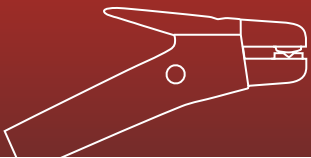

ROHRMAN
SCHWEISSTECHNIK



SR-18/F

TIG-Torches SR-18, SR-18 F				
Capacity at 100% duty cycle (10 min. cycle)	Type of cooling	Electrode diameter	Standard	Connection
Direct current (DC) 340 A Alternating current (AC) 240 A	Water cooled	0.5–4.0 mm	Conform to EN 60974-7 CE	Suitable for any power supply in the market

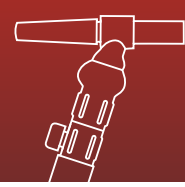
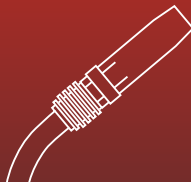
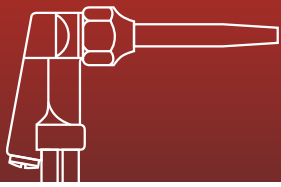

SR-18/F

340 A – DC – 100% Duty Cycle
240 A – AC – 100% Duty Cycle

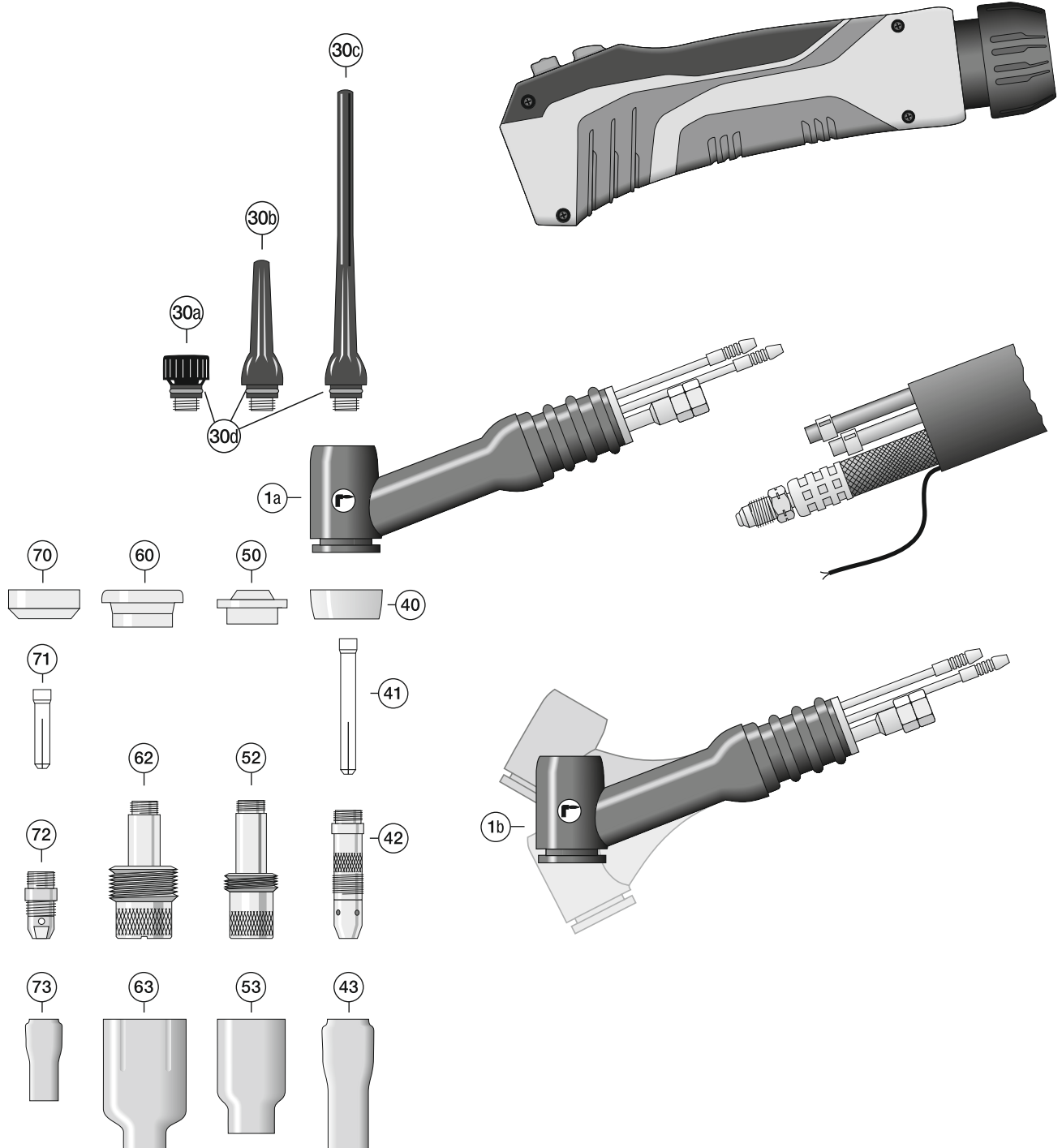



TIG Torches SR-18 with Highflex (HF) Torch Package and Basic Connection

Position	Article Description	Order Number
	SR-18/4 m, Leather+Rubber, G-Cu-W, RTC-DD	84B1018004EA01D
	SR-18/8 m, Leather+Rubber, G-Cu-W, RTC-DD	84B1018008EA01D

TIG Torches SR-18 F with Highflex (HF) Torch Package and Basic Connection

Position	Article Description	Order Number
	SR-18 F/4 m, Leather+Rubber, G-Cu-W, RTC-DD	84B1018204EA01D
	SR-18 F/8 m, Leather+Rubber, G-Cu-W, RTC-DD	84B1018208EA01D

Replacement Parts Torch Body

Position	Article Description	Order Number
1a	Torch Body SR-18	85600180
1b	Torch Body SR-18 F with Flexible Torch Body	85600182

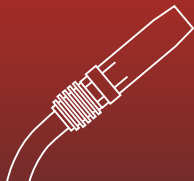
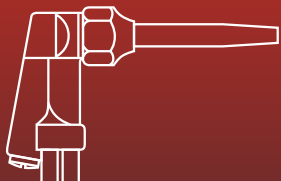

TIG Torches SR-18 with Highflex-Canvas (HFG) Torch Package and Basic Connection

Position	Article Description	Order Number
	SR-18/ 4 m, Leather+Canvas, G-Cu-W, RTC-DD	84F1018004EA01D
	SR-18/ 8 m, Leather+Canvas, G-Cu-W, RTC-DD	84F1018008EA01D
	SR-18/12 m, Leather+Canvas, G-Cu-W, RTC-DD	84F1018012EA01D
	SR-18/16 m, Leather+Canvas, G-Cu-W, RTC-DD	84F1018016EA01D

TIG Torches SR-18 F with Highflex-Canvas (HFG) Torch Package and Basic Connection

Position	Article Description	Order Number
	SR-18 F/ 4 m, Leather+Canvas, G-Cu-W, RTC-DD	84F1018204EA01D
	SR-18 F/ 8 m, Leather+Canvas, G-Cu-W, RTC-DD	84F1018208EA01D
	SR-18 F/12 m, Leather+Canvas, G-Cu-W, RTC-DD	84F1018212EA01D
	SR-18 F/16 m, Leather+Canvas, G-Cu-W, RTC-DD	84F1018216EA01D



SR-18 SC

TIG-Torches SR-18 SC				
Capacity at 100% duty cycle (10 min. cycle)	Type of cooling	Electrode diameter	Standard	Connection
Direct current (DC) 400 A Alternating current (AC) 280 A	Water cooled	1.0–4.8 mm	Conform to EN 60974-7 CE	Suitable for any power supply in the market

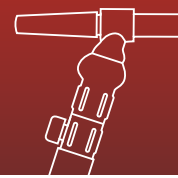
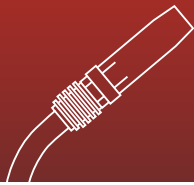
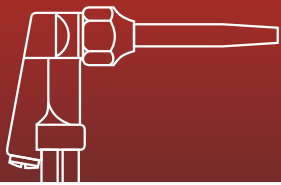

SR-18 SC

400 A – DC – 100% Duty Cycle
280 A – AC – 100% Duty Cycle

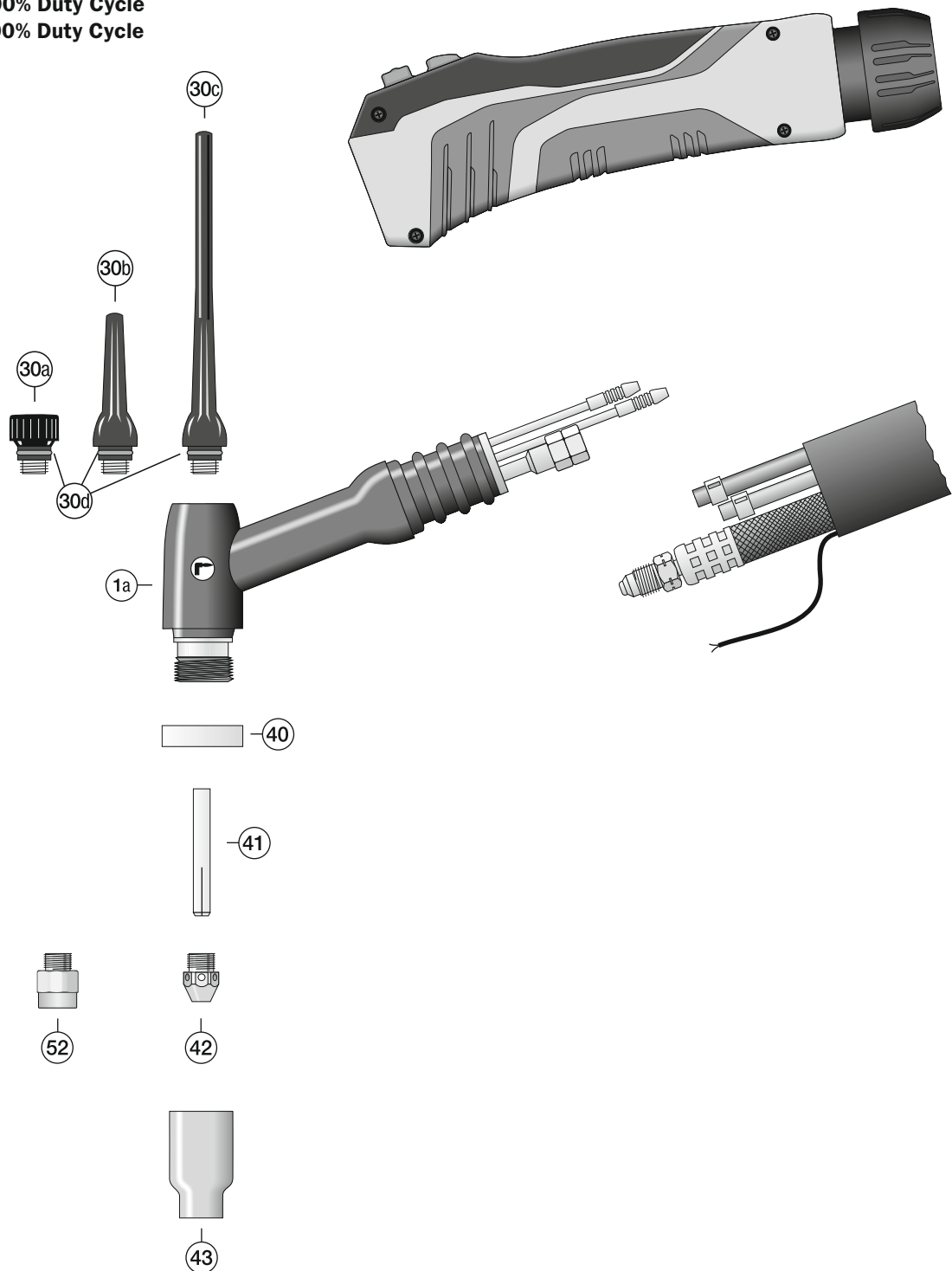



TIG Torches SR-18 SC with Highflex (HF) Torch Package and Basic Connection

Position	Article Description	Order Number
	SR-18 SC/4 m, Leather+Rubber, G-Cu-W, RTC-DD	84B1018C04EA01D
	SR-18 SC/8 m, Leather+Rubber, G-Cu-W, RTC-DD	84B1018C08EA01D

Replacement Parts Torch Body

Position	Article Description	Order Number
1a	Torch Body SR-18 SC	8560018C

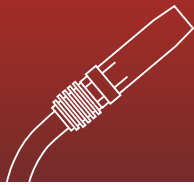
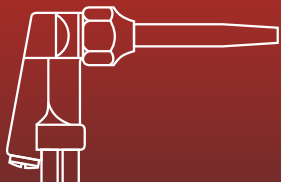

TIG Torches SR-18 SC with Highflex-Canvas (HFG) Torch Package and Basic Connection

Position	Article Description	Order Number
	SR-18 SC/ 4 m, Leather+Canvas, G-Cu-W, RTC-DD	84F1018C04EA01D
	SR-18 SC/ 8 m, Leather+Canvas, G-Cu-W, RTC-DD	84F1018C08EA01D
	SR-18 SC/12 m, Leather+Canvas, G-Cu-W, RTC-DD	84F1018C12EA01D
	SR-18 SC/16 m, Leather+Canvas, G-Cu-W, RTC-DD	84F1018C16EA01D

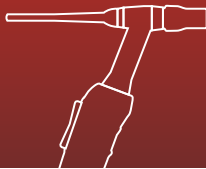
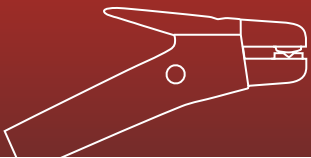

ROHRMAN
SCHWEISSTECHNIK



SR-20



SR-20 F3"

TIG-Torches SR-20, SR-20 F3", SR-20 F4"

Capacity at 100% duty cycle (10 min. cycle)	Type of cooling	Electrode diameter	Standard	Connection
Direct current (DC) 240 A Alternating current (AC) 170 A	Water cooled	0.5–3.2 mm	Conform to EN 60974-7 CE	Suitable for any power supply in the market



SR-20 H

TIG-Torches SR-20 H

Capacity at 100% duty cycle (10 min. cycle)	Type of cooling	Electrode diameter	Standard	Connection
Direct current (DC) 270 A Alternating current (AC) 190 A	Water cooled	0.5–3.2 mm	Conform to EN 60974-7 CE	Suitable for any power supply in the market

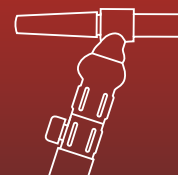
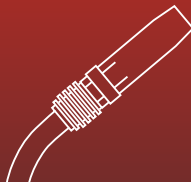
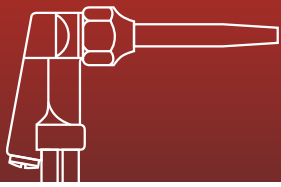

SR-20/F

240 A – DC – 100% Duty Cycle
170 A – AC – 100% Duty Cycle

SR-20 H

270 A – DC – 100% Duty Cycle
190 A – AC – 100% Duty Cycle

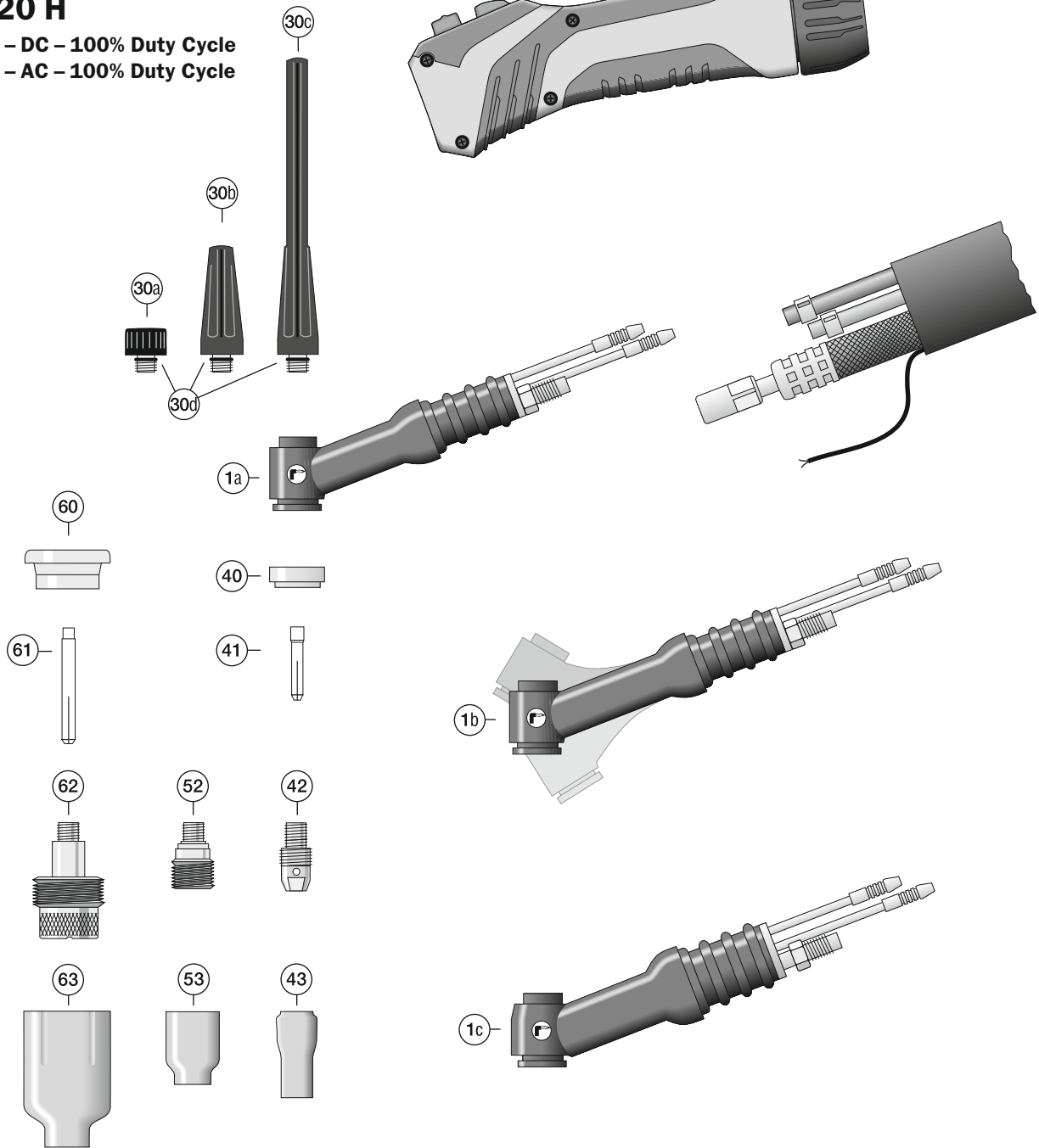

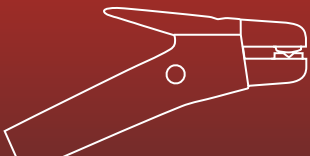

TIG Torches SR-20 with Highflex (HF) Torch Package and Basic Connection

Position	Article Description	Order Number
	SR-20/4 m, Leather+Rubber, G-Cu-W, RTC-DD	84B1020004EA01D
	SR-20/8 m, Leather+Rubber, G-Cu-W, RTC-DD	84B1020008EA01D

TIG Torches SR-20 F with Highflex (HF) Torch Package and Basic Connection

Position	Article Description	Order Number
	SR-20 F/4 m, Leather+Rubber, G-Cu-W, RTC-DD	84B1020204EA01D
	SR-20 F/8 m, Leather+Rubber, G-Cu-W, RTC-DD	84B1020208EA01D

TIG Torches SR-20 F3" with Highflex (HF) Torch Package and Basic Connection

Position	Article Description	Order Number
	SR-20 F3"/4 m, Leather+Rubber, G-Cu-W, RTC-DD	84B1020304EA01D
	SR-20 F3"/8 m, Leather+Rubber, G-Cu-W, RTC-DD	84B1020308EA01D

TIG Torches SR-20 F4" with Highflex (HF) Torch Package and Basic Connection

Position	Article Description	Order Number
	SR-20 F4"/4 m, Leather+Rubber, G-Cu-W, RTC-DD	84B1020404EA01D
	SR-20 F4"/8 m, Leather+Rubber, G-Cu-W, RTC-DD	84B1020408EA01D

TIG Torches SR-20 F5" with Highflex (HF) Torch Package and Basic Connection

Position	Article Description	Order Number
	SR-20 F5"/4 m, Leather+Rubber, G-Cu-W, RTC-DD	84B1020504EA01D
	SR-20 F5"/8 m, Leather+Rubber, G-Cu-W, RTC-DD	84B1020508EA01D

TIG Torches SR-20 H with Highflex (HF) Torch Package and Basic Connection

Position	Article Description	Order Number
	SR-20 H/4 m, Leather+Rubber, G-Cu-W, RTC-DD	84B1020H04EA01D
	SR-20 H/8 m, Leather+Rubber, G-Cu-W, RTC-DD	84B1020H08EA01D

Replacement Parts Torch Body

Position	Article Description	Order Number
1a	Torch Body SR-20	85600200
1b	Torch Body SR-20 F with Flexible Torch Body	85600202
	Torch Body SR-20 F3" (75 mm) with Flexible Torch Body	85600203
	Torch Body SR-20 F4" (100 mm) with Flexible Torch Body	85600204
	Torch Body SR-20 F5" (125 mm) with Flexible Torch Body	85600205
1c	Torch Body SR-20 H	8560020H

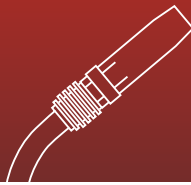
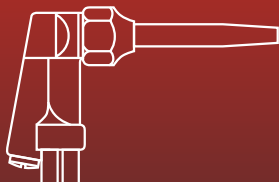

TIG Torches SR-20 with Highflex-Canvas (HFG) Torch Package and Basic Connection

Position	Article Description	Order Number
	SR-20/ 4 m, Leather+Canvas, G-Cu-W, RTC-DD	84F1020004EA01D
	SR-20/ 8 m, Leather+Canvas, G-Cu-W, RTC-DD	84F1020008EA01D
	SR-20/12 m, Leather+Canvas, G-Cu-W, RTC-DD	84F1020012EA01D
	SR-20/16 m, Leather+Canvas, G-Cu-W, RTC-DD	84F1020016EA01D

TIG Torches SR-20 F with Highflex-Canvas (HFG) Torch Package and Basic Connection

Position	Article Description	Order Number
	SR-20 F/ 4 m, Leather+Canvas, G-Cu-W, RTC-DD	84F1020204EA01D
	SR-20 F/ 8 m, Leather+Canvas, G-Cu-W, RTC-DD	84F1020208EA01D
	SR-20 F/12 m, Leather+Canvas, G-Cu-W, RTC-DD	84F1020212EA01D
	SR-20 F/16 m, Leather+Canvas, G-Cu-W, RTC-DD	84F1020216EA01D

TIG Torches SR-20 F3" with Highflex-Canvas (HFG) Torch Package and Basic Connection

Position	Article Description	Order Number
	SR-20 F3"/ 4 m, Leather+Canvas, G-Cu-W, RTC-DD	84F1020304EA01D
	SR-20 F3"/ 8 m, Leather+Canvas, G-Cu-W, RTC-DD	84F1020308EA01D
	SR-20 F3"/12 m, Leather+Canvas, G-Cu-W, RTC-DD	84F1020312EA01D
	SR-20 F3"/16 m, Leather+Canvas, G-Cu-W, RTC-DD	84F1020316EA01D

TIG Torches SR-20 F4" with Highflex-Canvas (HFG) Torch Package and Basic Connection

Position	Article Description	Order Number
	SR-20 F4"/ 4 m, Leather+Canvas, G-Cu-W, RTC-DD	84F1020404EA01D
	SR-20 F4"/ 8 m, Leather+Canvas, G-Cu-W, RTC-DD	84F1020408EA01D
	SR-20 F4"/12 m, Leather+Canvas, G-Cu-W, RTC-DD	84F1020412EA01D
	SR-20 F4"/16 m, Leather+Canvas, G-Cu-W, RTC-DD	84F1020416EA01D

TIG Torches SR-20 F5" with Highflex-Canvas (HFG) Torch Package and Basic Connection

Position	Article Description	Order Number
	SR-20 F5"/ 4 m, Leather+Canvas, G-Cu-W, RTC-DD	84F1020504EA01D
	SR-20 F5"/ 8 m, Leather+Canvas, G-Cu-W, RTC-DD	84F1020508EA01D
	SR-20 F5"/12 m, Leather+Canvas, G-Cu-W, RTC-DD	84F1020512EA01D
	SR-20 F5"/16 m, Leather+Canvas, G-Cu-W, RTC-DD	84F1020516EA01D

TIG Torches SR-20 H with Highflex-Canvas (HFG) Torch Package and Basic Connection

Position	Article Description	Order Number
	SR-20 H/ 4 m, Leather+Canvas, G-Cu-W, RTC-DD	84F1020H04EA01D
	SR-20 H/ 8 m, Leather+Canvas, G-Cu-W, RTC-DD	84F1020H08EA01D
	SR-20 H/12 m, Leather+Canvas, G-Cu-W, RTC-DD	84F1020H12EA01D
	SR-20 H/16 m, Leather+Canvas, G-Cu-W, RTC-DD	84F1020H16EA01D



ROHRMAN
SCHWEISSTECHNIK



SR-24 G

TIG-Torches SR-24 G				
Capacity at 35% duty cycle (10 min. cycle)	Type of cooling	Electrode diameter	Standard	Connection
Direct current (DC) 110 A Alternating current (AC) 75 A	Air cooled	0.5–1.6 mm	Conform to EN 60974-7 CE	Suitable for any power supply in the market

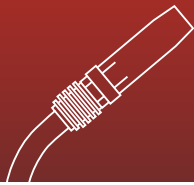
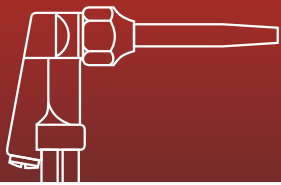

SR-24 G

110 A – DC – 35% Duty Cycle

75 A – AC – 35% Duty Cycle

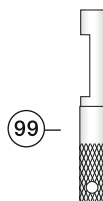
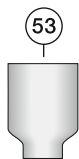
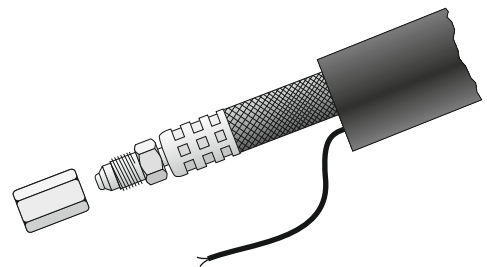
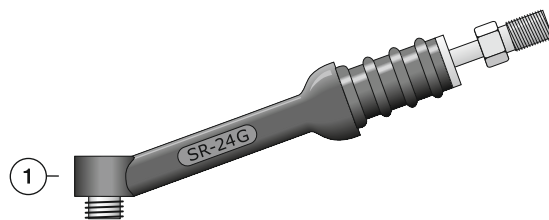



TIG Torches SR-24 G with Highflex (HF) Torch Package and Basic Connection

Position	Article Description	Order Number
	SR-24 G/4 m, Leather+Rubber, G-Cu-W, RTC-DD	84B1024G04EB01D
	SR-24 G/8 m, Leather+Rubber, G-Cu-W, RTC-DD	84B1024G08EB01D

Replacement Parts Torch Body

Position	Article Description	Order Number
1	Torch Body SR-24 G	8560024G

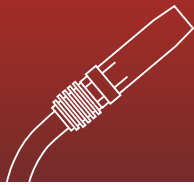
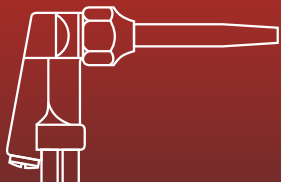

TIG Torches SR-24 G with Highflex-Canvas (HFG) Torch Package and Basic Connection

Position	Article Description	Order Number
	SR-24 G/ 4 m, Leather+Canvas, G-Cu-W, RTC-DD	84F1024G04EB01D
	SR-24 G/ 8 m, Leather+Canvas, G-Cu-W, RTC-DD	84F1024G08EB01D
	SR-24 G/12 m, Leather+Canvas, G-Cu-W, RTC-DD	84F1024G12EB01D
	SR-24 G/16 m, Leather+Canvas, G-Cu-W, RTC-DD	84F1024G16EB01D



ROHRMAN
SCHWEISSTECHNIK



SR-24 W

TIG-Torches SR-24 W				
Capacity at 100% duty cycle (10 min. cycle)	Type of cooling	Electrode diameter	Standard	Connection
Direct current (DC) 180 A Alternating current (AC) 125 A	Water cooled	0.5–2.4 mm	Conform to EN 60974-7 CE	Suitable for any power supply in the market

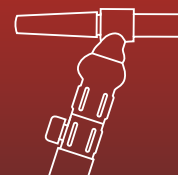
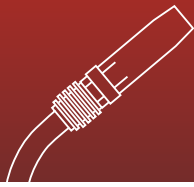
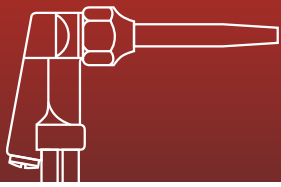

SR-24 W

180 A – DC – 100% Duty Cycle
125 A – AC – 100% Duty Cycle

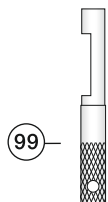
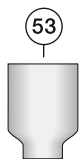
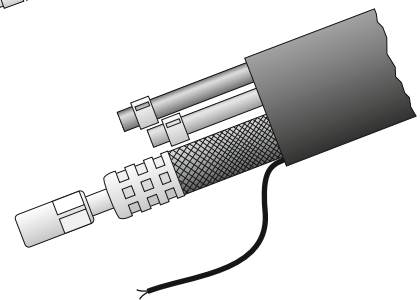
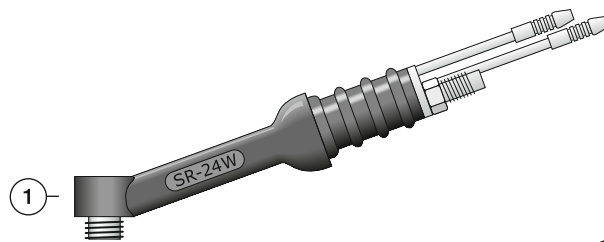



TIG Torches SR-24 W with Highflex (HF) Torch Package and Basic Connection

Position	Article Description	Order Number
	SR-24 W/4 m, Leather+Rubber, G-Cu-W, RTC-DD	84B1024W04EA01D
	SR-24 W/8 m, Leather+Rubber, G-Cu-W, RTC-DD	84B1024W08EA01D

Replacement Parts Torch Body

Position	Article Description	Order Number
1	Torch Body SR-24 W	8560024W

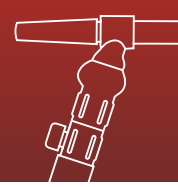
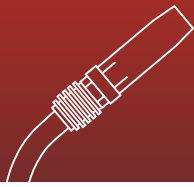
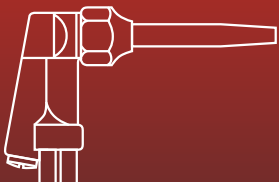

TIG Torches SR-24 W with Highflex-Canvas (HFG) Torch Package and Basic Connection

Position	Article Description	Order Number
	SR-24 W/ 4 m, Leather+Canvas, G-Cu-W, RTC-DD	84F1024W04EA01D
	SR-24 W/ 8 m, Leather+Canvas, G-Cu-W, RTC-DD	84F1024W08EA01D
	SR-24 W/12 m, Leather+Canvas, G-Cu-W, RTC-DD	84F1024W12EA01D
	SR-24 W/16 m, Leather+Canvas, G-Cu-W, RTC-DD	84F1024W16EA01D

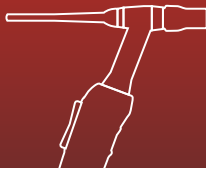
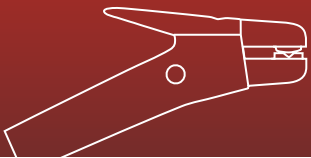

ROHRMAN
SCHWEISSTECHNIK



SR-26



SR-26 V

TIG-Torches SR-26, SR-26 V

Capacity at 35% duty cycle (10 min. cycle)	Type of cooling	Electrode diameter	Standard	Connection
Direct current (DC) 200 A Alternating current (AC) 140 A	Air cooled	0.5–3.2 mm	Conform to EN 60974-7 CE	Suitable for any power supply in the market

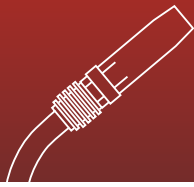
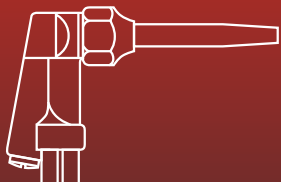

SR-26/F/V

200 A - DC - 35% Duty Cycle
140 A - AC - 35% Duty Cycle

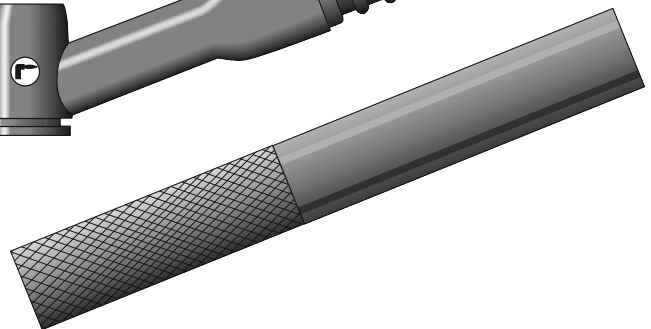
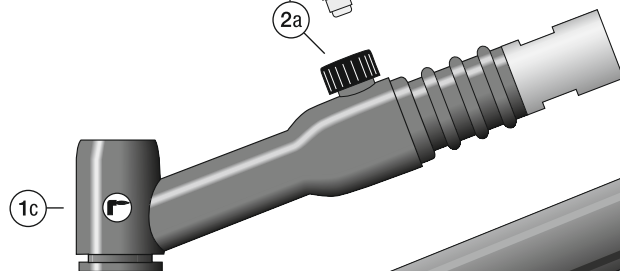
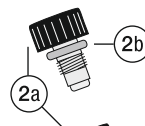
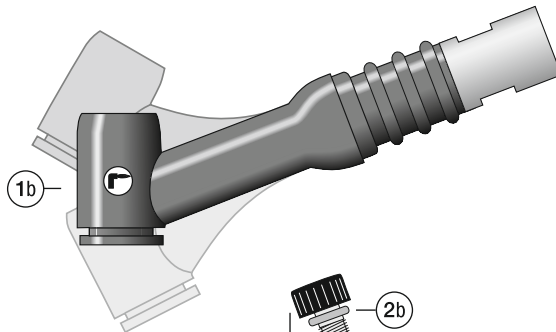
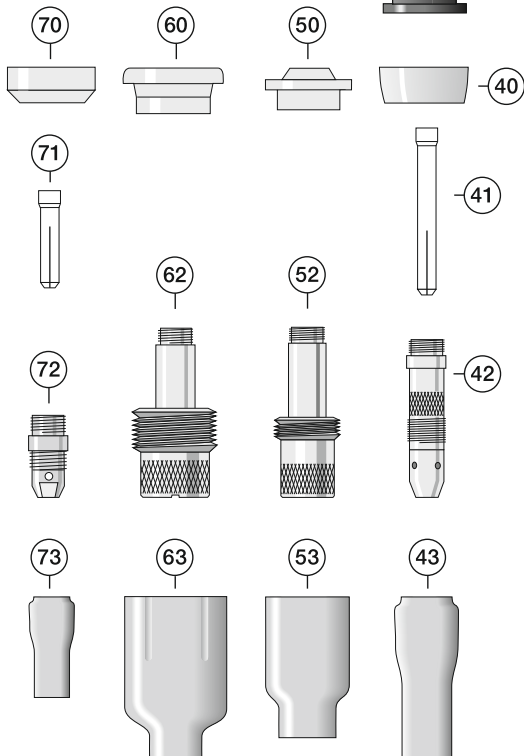
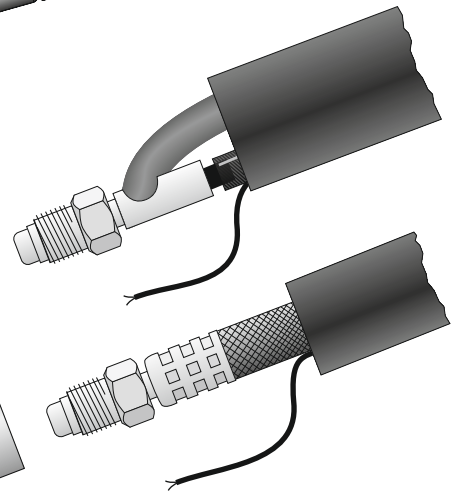
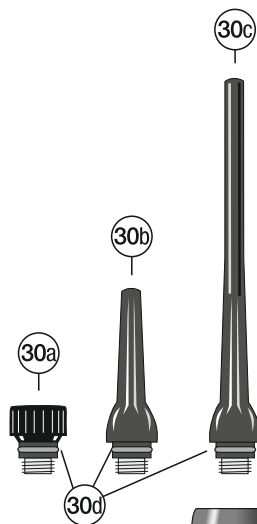
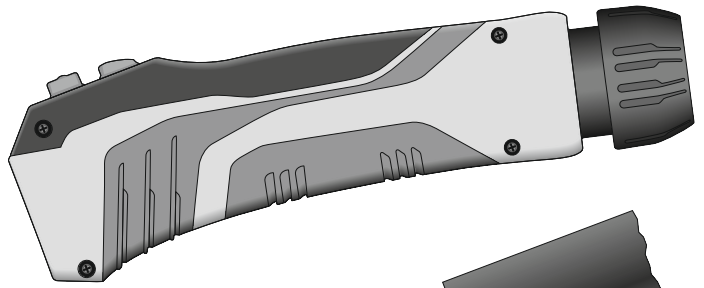



TIG Torches SR-26 with Highflex (HF) Torch Package and Basic Connection

Position	Article Description	Order Number
	SR-26/4 m, Leather+Rubber, G-Cu-W, RTC-DD	84B1026004EB01D
	SR-26/8 m, Leather+Rubber, G-Cu-W, RTC-DD	84B1026008EB01D

TIG Torches SR-26 F with Highflex (HF) Torch Package and Basic Connection

Position	Article Description	Order Number
	SR-26 F/4 m, Leather+Rubber, G-Cu-W, RTC-DD	84B1026204EB01D
	SR-26 F/8 m, Leather+Rubber, G-Cu-W, RTC-DD	84B1026208EB01D

TIG Torches SR-26 V with Power-/ Gas- Cable and Basic Connection

Position	Article Description	Order Number
	SR-26 V/4 m, T-Cu, Handle Round	8407026V04E030
	SR-26 V/8 m, T-Cu, Handle Round	8407026V08E030

TIG Torches SR-26 FV with Power-/ Gas- Cable and Basic Connection

Position	Article Description	Order Number
	SR-26 FV/4 m, T-Cu, Handle Round	8407026Y04E030
	SR-26 FV/8 m, T-Cu, Handle Round	8407026Y08E030

Replacement Parts Torch Body

Position	Article Description	Order Number
1a	Torch Body SR-26	85600260
1b	Torch Body SR-26 F with Flexible Torch Body	85600262
1c	Torch Body SR-26 V with Valve Knob	8560026V
	Torch Body SR-26 FV with Flexible Torch Body and Valve Knob	8560026Y
2a	Valve Knob for SR-26 V	85511001
2b	O-Ring for Valve Knob	85509008

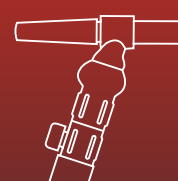
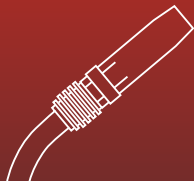
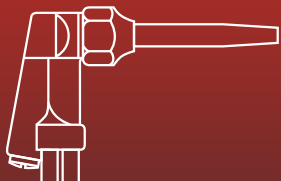

TIG Torches SR-26 with Highflex-Canvas (HFG) Torch Package and Basic Connection

Position	Article Description	Order Number
	SR-26/ 4 m, Leather+Canvas, G-Cu-W, RTC-DD	84F1026004EB01D
	SR-26/ 8 m, Leather+Canvas, G-Cu-W, RTC-DD	84F1026008EB01D
	SR-26/12 m, Leather+Canvas, G-Cu-W, RTC-DD	84F1026012EB01D
	SR-26/16 m, Leather+Canvas, G-Cu-W, RTC-DD	84F1026016EB01D

TIG Torches SR-26 F with Highflex-Canvas (HFG) Torch Package and Basic Connection

Position	Article Description	Order Number
	SR-26 F/ 4 m, Leather+Canvas, G-Cu-W, RTC-DD	84F1026204EB01D
	SR-26 F/ 8 m, Leather+Canvas, G-Cu-W, RTC-DD	84F1026208EB01D
	SR-26 F/12 m, Leather+Canvas, G-Cu-W, RTC-DD	84F1026212EB01D
	SR-26 F/16 m, Leather+Canvas, G-Cu-W, RTC-DD	84F1026216EB01D

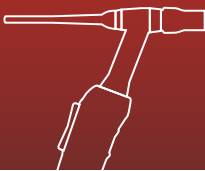
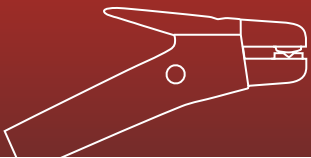

ROHRMAN
SCHWEISSTECHNIK



TIG Handle RTC
Rohrman TIG Comfort



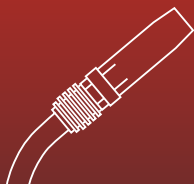
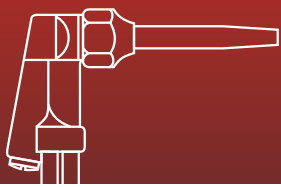

TIG Handle RTC

13a

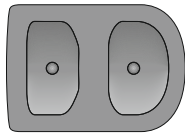

ED/DD

13b

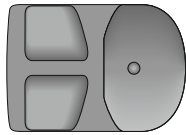

ED-UpDown

13c

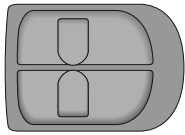

DD-Updown

13d

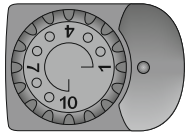

ED-Poti

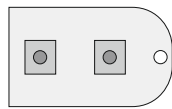

12a

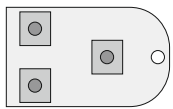

12b

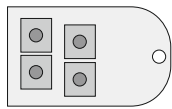

12c

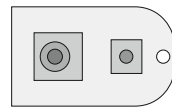

12d

12s



14

15b

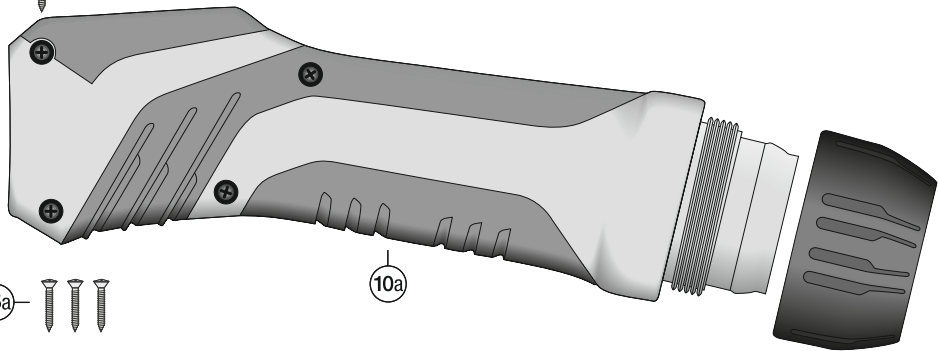

10a

11a

15a



15b

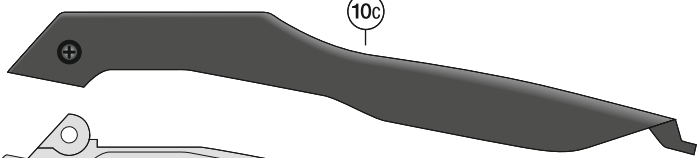

10c

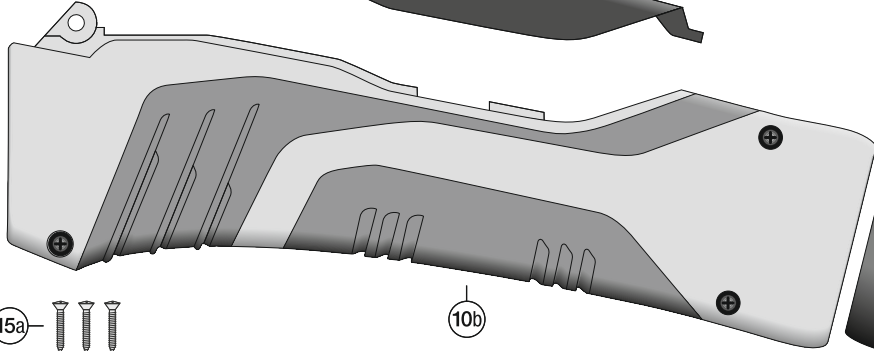

10b

11b

11a

15a



10d

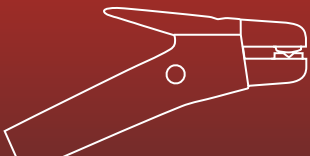

Replacement Parts Handle RTC

Position	Article Description	Order Number
	Handle-Set RTC Small ED/DD Black (9/17/20/24)	85503011D10-SW1
	Handle-Set RTC Small ED-UpDown Black (9/17/20/24)	85503011V10-SW1
	Handle-Set RTC Small DD-UpDown Black (9/17/20/24)	85503011U10-SW1
	Handle-Set RTC Small ED-Poti 10k Black (9/17/20/24)	85503011Q10-SW1
	Handle-Set RTC Small ED/DD Red (9/17/20/24)	85503011D10-RT1
	Handle-Set RTC Small ED-UpDown Red (9/17/20/24)	85503011V10-RT1
	Handle-Set RTC Small DD-UpDown Red (9/17/20/24)	85503011U10-RT1
	Handle-Set RTC Small ED-Poti 10k Red (9/17/20/24)	85503011Q10-RT1
	Handle-Set RTC Large ED/DD Black (18/18SC/26)	85503012D10-SW1
	Handle-Set RTC Large ED-UpDown Black (18/18SC/26)	85503012V10-SW1
	Handle-Set RTC Large DD-UpDown Black (18/18SC/26)	85503012U10-SW1
	Handle-Set RTC Large ED-Poti 10k Black (18/18SC/26)	85503012Q10-SW1
	Handle-Set RTC Large ED/DD Red (18/18SC/26)	85503012D10-RT1
	Handle-Set RTC Large ED-UpDown Red (18/18SC/26)	85503012V10-RT1
	Handle-Set RTC Large DD-UpDown Red (18/18SC/26)	85503012U10-RT1
	Handle-Set RTC Large ED-Poti 10k Red (18/18SC/26)	85503012Q10-RT1
10a	Handle Small (Left+Right) Black	8550301Z1-1SW00
	Handle Small (Left+Right) Red	8550301Z1-1RT00
	Handle Small (Left+Right) Blue	8550301Z1-1BL00
10b	Handle Large (Left+Right) Black	8550301Z1-2SW00
	Handle Large (Left+Right) Red	8550301Z1-2RT00
	Handle Large (Left+Right) Blue	8550301Z1-2BL00
10c	Top Frame	8550301Z1-3SW
	Adapter Torch Body v4 (18/18SC/26)	8550301Z3-21
10d	Adapter Insert (Handle Large on Small)	8550301Z3-20
11a	Lock Nut	8550301Z2-4SW
11b	Ball Joint	8550301Z2-2SW
12a	PCB ED/DD	8550301Z5-1201
12b	PCB ED-UpDown	8550301Z5-1611
12c	PCB DD-UpDown	8550301Z5-1311
12d	PCB ED-Poti 10 kΩ	8550301Z5-1411-40
	PCB ED-Poti 1 kΩ	8550301Z5-1411-41
	PCB ED-Poti 4,7 kΩ (5,0 kΩ)	8550301Z5-1411-42
	PCB ED-Poti 47 kΩ (50 kΩ)	8550301Z5-1411-43
12s	Screw for PCB (Handle Large)	8550301Z5-91
13a	Switch Cover ED/DD	8550301Z4-1200GR
13b	Switch Cover ED-UpDown	8550301Z4-1610GR
13c	Switch Cover DD-UpDown (Set)	8550301Z4-1315GR
13d	Switch Cover ED-Poti (Set)	8550301Z4-1415GR
14	Adapter Torch Body v1 (9/17/20/24)	8550301Z3-11
	Adapter Torch Body v2	8550301Z3-13
	Adapter Torch Body v3 (2-pc)	8550301Z3-14
	<i>for small handle, with 10d also for large handle</i>	
15a	Screw L=13 mm	8550301Z1-91
15b	Screw L=19 mm	8550301Z1-92

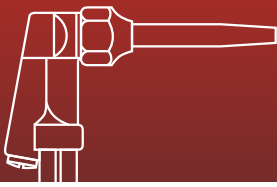

Notes

A large area of the page is covered by horizontal lines, serving as a template for notes.



Torch Packages



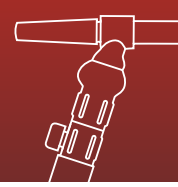
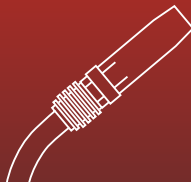
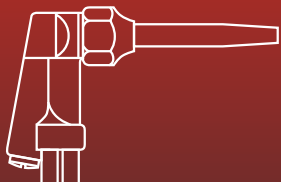

Torch Packages

SR-9/17/24 G

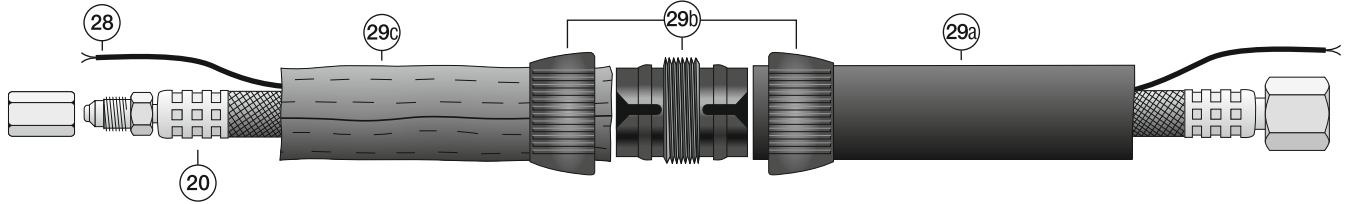

**3/8"-24 UNF Right Hand, Male (AD)
+ Adapter**

G¹/₄" Right Hand, Swivel Nut (ÜM)

SR-26

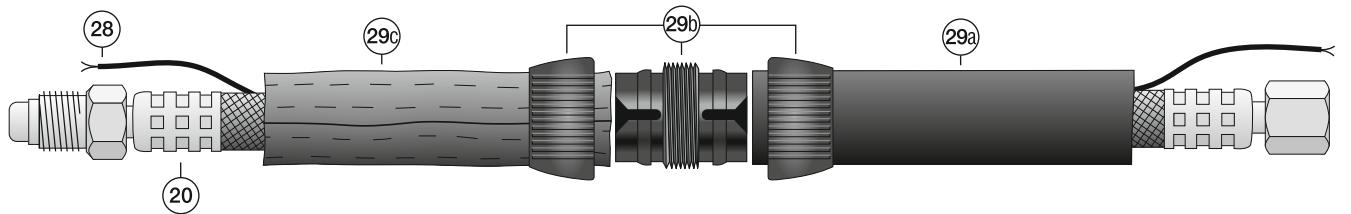

5/8"-18 UNF Right Hand, Male (AD)

G¹/₄" Right Hand, Swivel Nut (ÜM)

SR-20/24 W

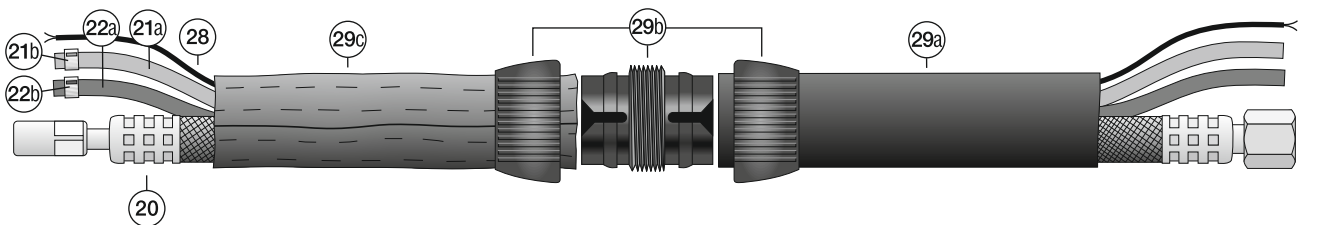

1/4"-28 UNF Right Hand, Swivel Nut (ÜM)

M12x1 Right Hand, Swivel Nut (ÜM)

SR-18/18 SC

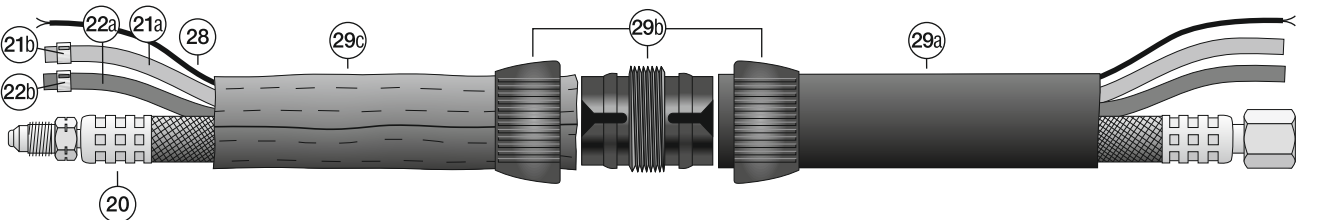

3/8"-24 UNF Left Hand, Male (AD)

M12x1 Right Hand, Swivel Nut (ÜM)



Replacement Parts Torch Packages

Position	Article Description	Order Number
20	Power Cable/ 4 m, Rubber, Strand-Cu, SR-9	821009004G1/4#
	Power Cable/ 8 m, Rubber, Strand-Cu, SR-9	821009008G1/4#
	Power Cable/12 m, Rubber, Strand-Cu, SR-9	821009012G1/4#
	Power Cable/16 m, Rubber, Strand-Cu, SR-9	821009016G1/4#
20	Power Cable/ 4 m, Rubber, Strand-Cu, SR-17	821017004G1/4#
	Power Cable/ 8 m, Rubber, Strand-Cu, SR-17	821017008G1/4#
	Power Cable/12 m, Rubber, Strand-Cu, SR-17	821017012G1/4#
	Power Cable/16 m, Rubber, Strand-Cu, SR-17	821017016G1/4#
20	Power Cable/ 4 m, Rubber, Strand-Cu, SR-24G	821024G04G1/4#
	Power Cable/ 8 m, Rubber, Strand-Cu, SR-24G	821024G08G1/4#
	Power Cable/12 m, Rubber, Strand-Cu, SR-24G	821024G12G1/4#
	Power Cable/16 m, Rubber, Strand-Cu, SR-24G	821024G16G1/4#
20	Power Cable/ 4 m, Rubber, Strand-Cu, SR-26	821026004G1/4#
	Power Cable/ 8 m, Rubber, Strand-Cu, SR-26	821026008G1/4#
	Power Cable/12 m, Rubber, Strand-Cu, SR-26	821026012G1/4#
	Power Cable/16 m, Rubber, Strand-Cu, SR-26	821026016G1/4#
20	Power Cable/ 4 m, Rubber, Strand-Cu, SR-20/24W	821020004M12X1#
	Power Cable/ 8 m, Rubber, Strand-Cu, SR-20/24W	821020008M12X1#
	Power Cable/12 m, Rubber, Strand-Cu, SR-20/24W	821020012M12X1#
	Power Cable/16 m, Rubber, Strand-Cu, SR-20/24W	821020016M12X1#
20	Power Cable/ 4 m, Rubber, Strand-Cu, SR-20H	821020H04M12X1#
	Power Cable/ 8 m, Rubber, Strand-Cu, SR-20H	821020H08M12X1#
	Power Cable/12 m, Rubber, Strand-Cu, SR-20H	821020H12M12X1#
	Power Cable/16 m, Rubber, Strand-Cu, SR-20H	821020H16M12X1#
20	Power Cable/ 4 m, Rubber, Strand-Cu, SR-18	821018004M12x1#
	Power Cable/ 8 m, Rubber, Strand-Cu, SR-18	821018008M12X1#
	Power Cable/12 m, Rubber, Strand-Cu, SR-18	821018012M12X1#
	Power Cable/16 m, Rubber, Strand-Cu, SR-18	821018016M12x1#
20	Power Cable/ 4 m, Rubber, Strand-Cu, SR-18SC	821018C04M12X1#
	Power Cable/ 8 m, Rubber, Strand-Cu, SR-18SC	821018C08M12X1#
	Power Cable/12 m, Rubber, Strand-Cu, SR-18SC	821018C12M12X1#
	Power Cable/16 m, Rubber, Strand-Cu, SR-18SC	821018C16M12X1#
21a	Hose Overbraided Rubber 5x8 Blue – Coil 100 m	855130508B
21b	1-Ear-Clamp with Innerlayer 9,5	855200095
22a	Hose Overbraided Rubber 5x8 Black – Coil 100 m	855130508S
22b	1-Ear-Clamp with Innerlayer 9,5	855200095
22a	Hose Overbraided Rubber 4x6 Black – Coil 100 m	855130406S
22b	1-Ear-Clamp with Innerlayer 8,7	855200087
28	Control Cable 3-Wire – Coil 100 m	855180103034FD
	Control Cable 7-Wire – Coil 100 m	855180107025FD
	Control Cable 3-Wire Shielded – Coil 100 m	855180203034
	Control Cable 6-Wire Shielded – Coil 100 m	855180206034
29a	Cable Cover Sheath Rubber Ø 23 mm – Coil 50 m	8551402310
	Cable Cover Sheath Rubber Ø 26 mm – Coil 50 m	8551402610
	Cable Cover Sheath Canvas Ø 22 mm – Coil 40 m	85514122
	Cable Cover Sheath Canvas Ø 25 mm – Coil 40 m	85514125
29b	Adapter	8551002001
29c	Cable Cover Sheath/1 m Leather Ø 22 mm	85514Z0222
	Cable Cover Sheath/1 m Leather Ø 28 mm	85514Z0228

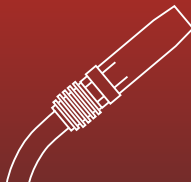
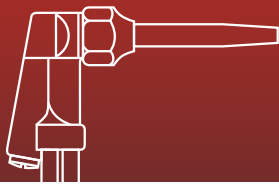

Torch Packages HF (Highflex-Rubber)

Position	Article Description	Order Number
	Package/4 m, Leather+Rubber, G-Cu-W, SR-9	83B1009004G1/4#
	Package/8 m, Leather+Rubber, G-Cu-W, SR-9	83B1009008G1/4#
	Package/4 m, Leather+Rubber, G-Cu-W, SR-17	83B1017004G1/4#
	Package/8 m, Leather+Rubber, G-Cu-W, SR-17	83B1017008G1/4#
	Package/4 m, Leather+Rubber, G-Cu-W, SR-24G	83B1024G04G1/4#
	Package/8 m, Leather+Rubber, G-Cu-W, SR-24G	83B1024G08G1/4#
	Package/4 m, Leather+Rubber, G-Cu-W, SR-26	83B1026004G1/4#
	Package/8 m, Leather+Rubber, G-Cu-W, SR-26	83B1026008G1/4#
	Package/4 m, Leather+Rubber, G-Cu-W, SR-20/24W	83B1020004M12X1#
	Package/8 m, Leather+Rubber, G-Cu-W, SR-20/24W	83B1020008M12X1#
	Package/4 m, Leather+Rubber, G-Cu-W, SR-20H	83B1020H04M12X1#
	Package/8 m, Leather+Rubber, G-Cu-W, SR-20H	83B1020H08M12X1#
	Package/4 m, Leather+Rubber, G-Cu-W, SR-18	83B1018004M12X1#
	Package/8 m, Leather+Rubber, G-Cu-W, SR-18	83B1018008M12X1#
	Package/4 m, Leather+Rubber, G-Cu-W, SR-18SC	83B1018C04M12X1#
	Package/8 m, Leather+Rubber, G-Cu-W, SR-18SC	83B1018C08M12X1#

Torch Packages HFG (Highflex-Canvas)

Position	Article Description	Order Number
	Package/ 4 m, Leather+Canvas, G-Cu-W, SR-9	83F1009004G1/4#
	Package/ 8 m, Leather+Canvas, G-Cu-W, SR-9	83F1009008G1/4#
	Package/12 m, Leather+Canvas, G-Cu-W, SR-9	83F1009012G1/4#
	Package/16 m, Leather+Canvas, G-Cu-W, SR-9	83F1009016G1/4#
	Package/ 4 m, Leather+Canvas, G-Cu-W, SR-17	83F1017004G1/4#
	Package/ 8 m, Leather+Canvas, G-Cu-W, SR-17	83F1017008G1/4#
	Package/12 m, Leather+Canvas, G-Cu-W, SR-17	83F1017012G1/4#
	Package/16 m, Leather+Canvas, G-Cu-W, SR-17	83F1017016G1/4#
	Package/ 4 m, Leather+Canvas, G-Cu-W, SR-24G	83F1024G04G1/4#
	Package/ 8 m, Leather+Canvas, G-Cu-W, SR-24G	83F1024G08G1/4#
	Package/12 m, Leather+Canvas, G-Cu-W, SR-24G	83F1024G12G1/4#
	Package/16 m, Leather+Canvas, G-Cu-W, SR-24G	83F1024G16G1/4#
	Package/ 4 m, Leather+Canvas, G-Cu-W, SR-26	83F1026004G1/4#
	Package/ 8 m, Leather+Canvas, G-Cu-W, SR-26	83F1026008G1/4#
	Package/12 m, Leather+Canvas, G-Cu-W, SR-26	83F1026012G1/4#
	Package/16 m, Leather+Canvas, G-Cu-W, SR-26	83F1026016G1/4#
	Package/ 4 m, Leather+Canvas, G-Cu-W, SR-20/24W	83F1020004M12X1#
	Package/ 8 m, Leather+Canvas, G-Cu-W, SR-20/24W	83F1020008M12X1#
	Package/12 m, Leather+Canvas, G-Cu-W, SR-20/24W	83F1020012M12X1#
	Package/16 m, Leather+Canvas, G-Cu-W, SR-20/24W	83F1020016M12X1#
	Package/ 4 m, Leather+Canvas, G-Cu-W, SR-20H	83F1020H04M12X1#
	Package/ 8 m, Leather+Canvas, G-Cu-W, SR-20H	83F1020H08M12X1#
	Package/12 m, Leather+Canvas, G-Cu-W, SR-20H	83F1020H12M12X1#
	Package/16 m, Leather+Canvas, G-Cu-W, SR-20H	83F1020H16M12X1#
	Package/ 4 m, Leather+Canvas, G-Cu-W, SR-18	83F1018004M12X1#
	Package/ 8 m, Leather+Canvas, G-Cu-W, SR-18	83F1018008M12X1#
	Package/12 m, Leather+Canvas, G-Cu-W, SR-18	83F1018012M12X1#
	Package/16 m, Leather+Canvas, G-Cu-W, SR-18	83F1018016M12X1#
	Package/ 4 m, Leather+Canvas, G-Cu-W, SR-18SC	83F1018C04M12X1#
	Package/ 8 m, Leather+Canvas, G-Cu-W, SR-18SC	83F1018C08M12X1#
	Package/12 m, Leather+Canvas, G-Cu-W, SR-18SC	83F1018C12M12X1#
	Package/16 m, Leather+Canvas, G-Cu-W, SR-18SC	83F1018C16M12X1#

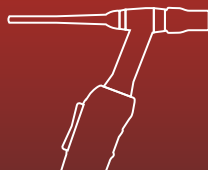

ROHRMAN
SCHWEISSTECHNIK

Notes

A large area of horizontal lines for taking notes, consisting of approximately 35 lines.

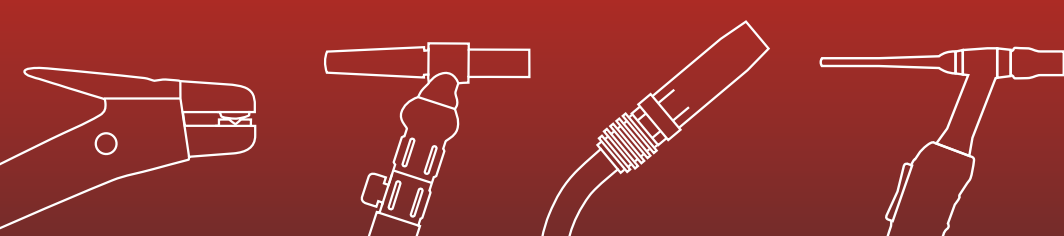

For more information contact your local welding supply distributor.

